

PRICE LIST 2025

Parasol collection

USA

Prices excluding sales taxes

Valid from November 1st 2024

Presented by

UMBROSA

UMBROSA INC
530 7th Avenue, Suite 902
NY 10018
(855) 285 6595
info@umbrosa.com

www.umbrosa.com





UMBROSA COMPANY

A Unique Shade Design, there is no better way to describe what Umbrosa stands for. Umbrosa offers stylish and sustainable shade solutions for the residential, commercial and hospitality market.

The umbrellas by Umbrosa are a clear statement of both elegance and simplicity, in combination with innovative ergonomics that puts "easy-to-use" to a higher standard. All design, development and assembly is done at our facility in Belgium. This guarantees for ultimate quality and flexibility to ensure a lifelong enjoyment of our solutions. Nature is an inexhaustible source of inspiration: trees and plants provide shade in a unique way. Umbrosa, and its team of designers, relies on the ingenious aspect of nature for the development of polyvalent and innovative shade creations, distinguished in many ways from the classic umbrella. Umbrosa is the specialist in state-of-the-art umbrellas for both residential and commercial applications. Our umbrella collections are exported to 95 countries and are used around the world in the most beautiful gardens and hotel properties.

TEAM

Umbrosa offers you the flexibility and personal service of a SME, while our numerous international references give the experience and charisma of a world player. You can count on the advice and guidance of one direct contact person. Our 40-member team from Belgium, organizes the entire production process, from product development to sales - and is also responsible for the worldwide shipping of our products. All products from our different ranges are manufactured in our factory Belgium. Umbrosa is your reliable partner and guarantees you affordable and sustainable luxury and Belgian quality.

Umbrosa has a daughter branch in Brazil, Umbrosa do Brazil. Here we produce all our parasols for the South American market. On January 1st 2022 Umbrosa INC was founded. Besides production in Belgium, Umbrosa also delivers the US market from a local warehouse.

VISION AND MISSION STATEMENT

Vision

Umbrosa wants to provide all terraces and gardens around the world with Unique Shade Solutions.

Mission

To manufacture high-end shade solutions in Belgium, that offer the optimal user experience, by designing unique, innovative and sustainable products, that have an impact on outdoor living.

Values

Passion | Communication | Perfection | Personal growth



TABLE OF CONTENTS

Umbrosa presentation		p. 02
Practical arrangements		p. 05
Nata NEW		p. 07
Paraflex NEW SIZE ALSO AVAILABLE AS PX		p. 12
Spectra NEW FRAME COLOR		p. 21
Icarus ALSO AVAILABLE AS PX		p. 29
Versa BESTSELLER		p. 35
Eclisum ALSO AVAILABLE AS PX		p. 42

DESIGNERS

Umbrosa distinguishes itself by a daring design that is both accessible and playful. To obtain this, we call on renowned designers - NG Design, Dirk Wynants, Pieter Willemyns, Peter Leleu, Hanne Besard, Lennart Delporte, Karim Rashid and Tore Bleuzé - each of them has a creative vision and innovative ideas which give a whole new meaning to the concept of a standard umbrella.

Karim Rashid

Visionary and prolific, Karim Rashid is one of the most unique faces within the design world today. With more than 4,000 designs in production, more than 400 awards to his name and working in 47 countries, Karim's ability to transcend typology continues to make him a force among designers of his generation. Karim Rashid's Eclisum UX is the result of the collaboration between Umbrosa and Karim Rashid.

MADE IN BELGIUM

All design, development and assembly is done in Belgium, which provides all parties with the best guarantee for quality and flexibility.

SPARE PARTS

Even long after the warranty period, we want to grant you a lifelong enjoyment of our products. Therefore we offer an extensive after sales service program. Not only can you order replacement canopies or frames, but you can also order each available individual component of your umbrella. To make it easy for you, we have detailed technical drawings of each product, so that you can quickly identify the piece you need. Umbrosa will charge you a limited fixed cost for picking and packing of spare parts. Detailed drawings can be found on our website under the section 'downloads', or in the installation manuals.



NG Design, Hanne Besard, Karim Rashid, Lennart Delporte, Tore Bleuzé, Pieter Willemyns, Peter Leleu, Dirk Wynants



PRODUCTION LEAD TIMES

QUICK SHIP = 8 DAYS 4 = production lead time 4 WEEKS

To serve you even better we have opened in May 2022 our US warehouse. In order to give you a clear and transparent lead time, Umbrosa works with simple indications of the availability date for departure, as well as the departure location. You will find a summary table with every collection. In that way you always know when goods will be available. Important note: the number of days and weeks are working days and working weeks. The most popular models are available as 'QS' or QUICKSHIP. That means that the items will be ready for shipping within a maximum of 8 working days, for orders from 1 to 5 items and after payment. A second group of models are available as '4', this means that the items will be ready for shipping within a maximum of 4 working weeks, for orders from 1 to 5 items and after payment. For orders of more than 5 items the exact lead time will depend on our stock levels. Please get in touch with Umbrosa for more information.

In summary these are our lead time categories:
 QS => ready for shipping within 8 working days
 4 => ready for shipping within 4 weeks

PRODUCTION TIME, COLOURS AND MODELS												
SPECTRA	SOLIDUM				COLORUM							
	Natural	Canvas	Grey	Taupe	Marble	Mint	Blush	Pepper	Almond	Sand	Flanelle	Black
	QS	QS	QS	4	4	4	4	4	4	4	4	4

USE OF PRODUCTCODES

Use our simplified product codes to place your order. We have simplified the Umbrosa codes and as a result they are now much more user-friendly. Please mention the correct code with every order. This not only saves us time, but helps you as a client as well and will limit the chance of mistakes.

Construction of the codes:

- name of the collection either in full or abbreviated
- the nature of the product or the form f.e. holder, pole, cover, round, square,...
- dimension/size of the umbrella
- the color of the umbrella needs to be filled out at the back (in the Quick Ship chart, the colors are mentioned above the codes)



QR-CODES

On each collection page you will find a QR code with a direct link to the product's technical data sheet. In this way you can easily find the extra information needed to close your sale.

COMPLAINTS AND AFTER SALES SERVICE

Every complaint or after sales service will be treated with the utmost care once we have received the following information:

- Commercial Invoice
- Photos or video showing the problem
- Description of the issue

FABRICS

Umbrosa has two collections of parasol fabrics. The Solidum colors are standard colours. The fabric is 100% Acryl and is made by Dickson. The Colorum collection contains the more exclusive colors. These fabrics, also 100% Acrylic, are manufactured by Dickson (Sunbrella) or Tuvatextil (Agora).

SOLIDUM: Acryl 250 gr/m2 / Colour Rating 7/8 (max = 8) / Water repellent

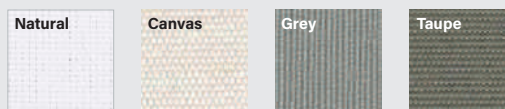

COLORUM: Acryl 260 gr/m2 / colour Rating 7/8 (max = 8) / Water repellent

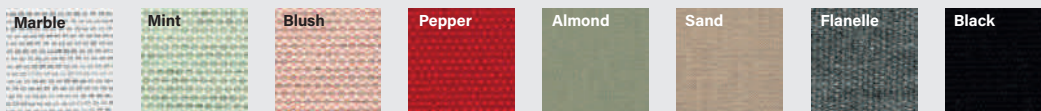

UMBROSA COLLECTIONS

OVERVIEW UMBROSA PARASOL COLLECTIONS			
	STANDARD	UX	PX
NATA	•	•	
PARAFLEX	•	•	•
SPECTRA	•		
VERSA		•	•
ICARUS	•	•	•
ECLIPSUM		•	•



STANDARD COLLECTION

Each model of the standard collection is available with 12 different fabric colours. In this collection, we offer Quick Ship models that can leave our warehouse within 8 working days. The rest of the models have a production time of 4 weeks.



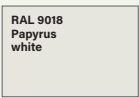
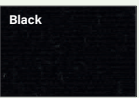
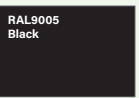

UX-COLLECTION

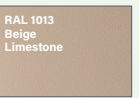
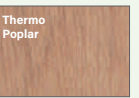
Each UX parasol (Unique experience) is a unique combination of colour, shape and materials. **Depending on the collection**, we have up to 8 fixed UX combinations: Full Black, Architecture, Sand, Latte, Safari, Nostalgic Plu, Nostalgic Roman and Nostalgic Zen. These products have a production lead time of 4 weeks.

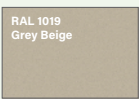
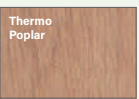
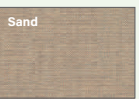
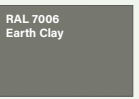
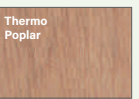
UX combinations

Architecture		Full Black		Sand		
Canopy	Frame + base	Canopy	Frame + base	Canopy	Frame + base	Cover base
						

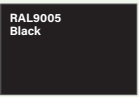
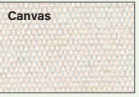
Latte			Safari		
Canopy	Frame + base	Cover base	Canopy	Frame + base	Cover base
					

Plu		Roman		Zen	
Canopy	Frame	Canopy	Frame	Canopy	Frame
					

PX COLLECTION

A PX parasol is a personalized version of a UX model, put together according to your personal taste or that of your customer. PX stands for "Personal Experience" and means that you can freely combine the color of the frame, canopy and parasol base within the colors offered. These products have a production lead time of 4 weeks.

NATA

NEW

CONCEPT



Quick access to full
technical data sheet



The Nata center post umbrella is a sophisticated and user-friendly addition to any outdoor environment. With its simple design, this parasol offers a timeless aesthetic that perfectly suits both small and large projects.

DESIGNER

Umbrosa Design Team

USP

Simplicity meets elegance.

SELLING POINTS

- Elegant and compact center post umbrella
- Center post umbrella with tilt function for standard version, the UX version has no tilt function
- Very easy to open and close
- Protection cover is optional

VERSIONS

NATA STANDARD

BLACK
RAL 9005

BEIGE
LIMESTONE
RAL 1013



NATA ROUND
Ø 9'2.2"
Ø 10'6"
From \$ 1 402



NATA SQUARE
6'6.7" x 6'6.7"
7'6.6" x 7'6.6"
From \$ 1 220

NATA UX

BEIGE
LIMESTONE
RAL 1013

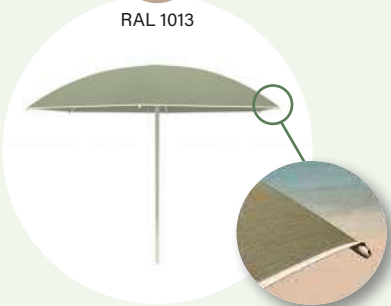

NOSTALGIC PLU
Ø 9'2.2"
From \$ 1 980

GREY
BEIGE
RAL 1019



NOSTALGIC ZEN
Ø 9'2.2"
From \$ 1 720

BLACK
RAL 9005

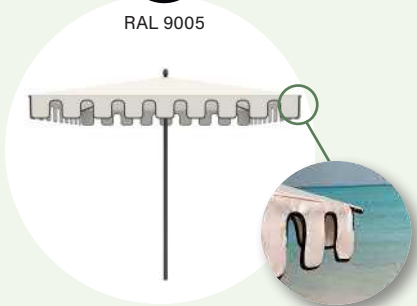

NOSTALGIC ROMAN
7'6.6" x 7'6.6"
From \$ 1 720



NATA STANDARD

QUICK SHIP

PRODUCTION TIME, COLORS AND MODELS												
NATA COLOR	SOLIDUM				COLORUM							
	Natural	Canvas	Grey	Taupe	Marble	Mint	Blush	Pepper	Almond	Sand	Flanelle	Black
ROUND 9'2.2"	4	QS	4	4	4	4	4	4	4	4	4	4
ROUND 10'6"	4	QS	4	4	4	4	4	4	4	4	4	4
SQUARE 6'6.7"	4	QS	4	4	4	4	4	4	4	4	4	4
SQUARE 7'6.6"	4	QS	4	4	4	4	4	4	4	4	4	4

QS = 8 working days / 4 = 4 weeks production time



NATA ROUND

NATA ROUND		PRICE frame + canopy			
 Black Frame	Beige Limestone Frame	Dimension	Fabric	⁽¹⁾	Concrete base incl. ⁽²⁾
NATT280ROBLACK-COLOUR	NATT280ROLIME-COLOUR	Ø 9'2.2"	Solidum	\$ 1 402	\$ 1 936
NATT280ROBLACK-COLOUR	NATT280ROLIME-COLOUR	Ø 9'2.2"	Colorum	\$ 1 542	\$ 2 076
NATT320ROBLACK-COLOUR	NATT320ROLIME-COLOUR	Ø 10'6"	Solidum	\$ 1 738	\$ 2 272
NATT320ROBLACK-COLOUR	NATT320ROLIME-COLOUR	Ø 10'6"	Colorum	\$ 1 912	\$ 2 446



NATA SQUARE



NATA SQUARE		PRICE frame + canopy			
 Black Frame	Beige Limestone Frame	Dimension	Fabric	⁽¹⁾	Concrete base incl. ⁽²⁾
NATT200SQBLACK-COLOUR	NATT200SQLIME-COLOUR	6'6.7"	Solidum	\$ 1 220	\$ 1 754
NATT200SQBLACK-COLOUR	NATT200SQLIME-COLOUR	6'6.7"	Colorum	\$ 1 342	\$ 1 876
NATT230SQBLACK-COLOUR	NATT230SQLIME-COLOUR	7'6.6"	Solidum	\$ 1 464	\$ 1 998
NATT230SQBLACK-COLOUR	NATT230SQLIME-COLOUR	7'6.6"	Colorum	\$ 1 610	\$ 2 144

⁽¹⁾ Support not included

⁽²⁾ Use on parasol base

NATA STANDARD

MOUNTING OPTIONS AND BASES

		Description	Price excl. sales taxes
Round support		Support required for fixing on a hard surface.	\$ 294
ROUNDSUPPORTTYPE2			
Soft ground		Concrete anchor to anchor pole through concrete in soft ground - to be used in conjunction with support.	\$ 357
INGROUNDANCHORTYPE1			
Concrete bases		Round concrete base Natural, 40 kg.	\$ 534
CONCRETEBASE40			
CONCRETEBASE40BLACK			

REPLACEMENT CANOPIES - PROTECTION COVER

	Shape	Dimension	Fabric	Price excl. sales taxes
NATA280COVERRO-COLOUR	ROUND	9'2.2"	Solidum	\$ 648
NATA280COVERRO-COLOUR			Colorum	\$ 788
NATA320COVERRO-COLOUR		10'6"	Solidum	\$ 804
NATA320COVERRO-COLOUR			Colorum	\$ 978
NATA200COVERSQ-COLOUR	SQUARE	6'6.7"	Solidum	\$ 598
NATA200COVERSQ-COLOUR			Colorum	\$ 720
NATA230COVERSQ-COLOUR		7'6.6"	Solidum	\$ 742
NATA230COVERSQ-COLOUR			Colorum	\$ 888
PFPROTECTION	Cover bag one size! Fits all Nata models - stick included - the cover needs to be folded for smaller models. Material: Polyester.			\$ 192



NATA UX

Nata UX collection - production lead time: 4 weeks.

NATA UX	PRICE frame + canopy			
	Dimension	Fabric	(1)	Concrete base incl. (2)
PLU280ROLIME-ALMON	Ø 9'2.2"	Almond	\$ 1 980	\$ 2 514
ZEN280ROGRBE-CANVA	Ø 9'2.2"	Canvas	\$ 1 720	\$ 2 254
ROM230SQBLACK-CANVA	7'6.6" x 7'6.6"	Canvas	\$ 1 720	\$ 2 254

Nata UX combinations

Nostalgic Plu		Nostalgic Zen		Nostalgic Roman	
Canopy	Frame + base	Canopy	Frame + base	Canopy	Frame + base
Almond	RAL 1013 Beige Limestone	Canvas	RAL 1019 Grey Beige	Canvas	RAL9005 Black

REPLACEMENT CANOPIES - PROTECTION COVER

	Dimension	Fabric	Price excl. sales taxes
PLU280COVERRO-ALMON	Ø 9'2.2"	Almond	\$ 960
ZEN280COVERRO-CANVA	Ø 9'2.2"	Canvas	\$ 896
ROM230COVERSQ_CANVA	7'6.6" x 7'6.6"	Canvas	\$ 1 070
NTPROTECTION_UX	Protection cover (Flanelle) for Nostalgic Zen and Roman.		\$ 308
PLPROTECTION_UX	Protection cover (Flanelle) for Nostalgic Plu.		\$ 476

NATA STANDARD

NATA UX

	NATA STANDARD			NATA UX		
	A	B	D	E = A	F	
	cm/ft	cm/ft	mm/inch	cm/ft	cm/ft	
	$\pm 2\%$					
2m80/9' 2.2"	232/7' 7.3"	205/6' 8.7"	Ø50x2 / Ø2"x0.1"	232/7' 7.3"	56/1' 10"	
3m20/10' 6"	232/7' 7.3"	200/6' 6.7"	Ø50x2 / Ø2"x0.1"	232/7' 7.3"	56/1' 10"	
2m/6' 6.7"	232/7' 7.3"	205/6' 8.7"	Ø50x2 / Ø2"x0.1"	232/7' 7.3"	56/1' 10"	
2m30/7' 6.6"	232/7' 7.3"	200/6' 6.7"	Ø50x2 / Ø2"x0.1"	232/7' 7.3"	56/1' 10"	
PLU 2m80/9' 2.2"	232/7' 7.3"	180/5' 10.9"	Ø50x2 / Ø2"x0.1"	232/7' 7.3"	56/1' 10"	

(1) Support not included

(2) Use on parasol base

PARAFLEX

CONCEPT



Quick access to full
technical data sheet

Nothing beats the versatility of the human body. As a result, for the Paraflex, we let ourselves be inspired by the manoeuvrability and strength of the human arm. A space-saving solution, without a base and without a pole, which offers you the possibility to create shade wherever you want, by means of one, two or more umbrellas, according to your needs. The light and compact Paraflex offers maximum shade and is highly wind-resistant.

DESIGNER

Peter Leleu

USP

The world's most flexible parasol.

SELLING POINTS

- Ideal for patios where there is no room for a base or pole (Wallflex)
- Flexible arm provides shade where desired
- Several configurations possible
- Easy to assemble
- Very easy to handle and store

VERSIONS

PARAFLEX STANDARD ALU



PARAFLEX WALL
From \$ 2 065



PARAFLEX MONO
From \$ 2 876



PARAFLEX DUO
From \$ 5 417



PARAFLEX MULTI
From \$ 9 548

Square: 6'6.7" x 6'6.7" and 7'6.6" x 7'6.6"
Round: 8'10 m and 9'10"

PARAFLEX UX BLACK



PARAFLEX UX WALL
From \$ 2 723

Square: 6'6.7" x 6'6.7" and 7'6.6" x 7'6.6"

PARAFLEX PX BLACK



PARAFLEX PX
From \$ 2 723

Paraflex PX freely combinable:
2 sizes, 1 frame and arm color, 8 fabric colors

NEW

FABRIC COLORS

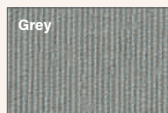
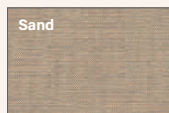
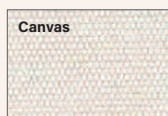
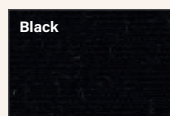



PARAFLEX STANDARD

QUICK SHIP

PRODUCTION TIME, COLORS AND MODELS												
PARAFLEX Color	SOLIDUM				COLORUM							
	Natural	Canvas	Grey	Taupe	Marble	Mint	Blush	Pepper	Almond	Sand	Flanelle	Black
ROUND 2,7 M / 8'10"	QS	QS	QS	QS	4	4	4	4	4	4	4	4
ROUND 3 M / 9'10"	4	QS	QS	QS	4	4	4	4	4	4	4	4
SQUARE 2 M / 6'6.7"	4	QS	QS	4	4	4	4	4	4	4	4	4
SQUARE 2,3 M / 7'6.6"	QS	QS	QS	QS	4	4	4	4	4	4	4	4

QS = 8 working days / 4 = 4 weeks production time



PARAFLEX WALL

PARAFLEX ROUND PRICE frame + canopy + NEO arm + protection cover			
	Dimension	Fabric	Price excl. sales taxes
PFWALL270NEO-COLOUR	2,7 m / 8'10"	Solidum	\$ 2 151
PFWALL270NEO-COLOUR	2,7 m / 8'10"	Colorum	\$ 2 402
PFWALL300NEO-COLOUR	3 m / 9'10"	Solidum	\$ 2 404
PFWALL300NEO-COLOUR	3 m / 9'10"	Colorum	\$ 2 721

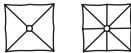
PARAFLEX SQUARE PRICE frame + canopy + NEO arm + protection cover			
	Dimension	Fabric	Price excl. sales taxes
PFWALL200NEO-COLOUR	2 m / 6'6.7"	Solidum	\$ 2 065
PFWALL200NEO-COLOUR	2 m / 6'6.7"	Colorum	\$ 2 299
PFWALL230NEO-COLOUR	2,3 m / 7'6.6"	Solidum	\$ 2 462
PFWALL230NEO-COLOUR	2,3 m / 7'6.6"	Colorum	\$ 2 790



PARAFLEX MONO

PARAFLEX ROUND PRICE frame + canopy + NEO arm + single pole & support + protection cover					
	Dimension	Fabric	Round support incl. ⁽¹⁾ ROUNDSUPPORTTYPE1	Concrete anchorage incl. ⁽²⁾ INGROUNDANCHORTYPE1	Mobile tile base incl. ⁽³⁾ TILEBASESTD-L-ALU
PFMONO270NEO-COLOUR	2,7 m / 8'10"	Solidum	\$ 2 961	\$ 3 318	\$ 4 605
PFMONO270NEO-COLOUR	2,7 m / 8'10"	Colorum	\$ 3 213	\$ 3 569	\$ 4 857
PFMONO300NEO-COLOUR	3 m / 9'10"	Solidum	\$ 3 215	\$ 3 571	\$ 4 859
PFMONO300NEO-COLOUR	3 m / 9'10"	Colorum	\$ 3 531	\$ 3 888	\$ 5 175

PARAFLEX SQUARE PRICE frame + canopy + NEO arm + single pole & support + protection cover					
	Dimension	Fabric	Round support incl. ⁽¹⁾ ROUNDSUPPORTTYPE1	Concrete anchorage incl. ⁽²⁾ INGROUNDANCHORTYPE1	Mobile tile base incl. ⁽³⁾ TILEBASESTD-L-ALU
PFMONO200NEO-COLOUR	2 m / 6'6.7"	Solidum	\$ 2 876	\$ 3 232	\$ 4 520
PFMONO200NEO-COLOUR	2 m / 6'6.7"	Colorum	\$ 3 110	\$ 3 466	\$ 4 754
PFMONO230NEO-COLOUR	2,3 m / 7'6.6"	Solidum	\$ 3 272	\$ 3 629	\$ 4 916
PFMONO230NEO-COLOUR	2,3 m / 7'6.6"	Colorum	\$ 3 600	\$ 3 957	\$ 5 245

⁽¹⁾ Fixation on hard ground

⁽²⁾ Fixation in soft ground

⁽³⁾ Use on mobile parasol base

PARAFLEX STANDARD

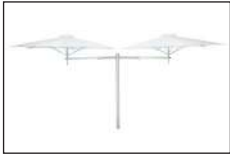

PARAFLEX DUO

PARAFLEX ROUND					
PRICE 2 X frame + 2 x canopy + 2 x NEO arm + multi pole & support + 2 x protection cover					
	Dimension	Fabric	Round support incl. ⁽¹⁾ UM-ROUNDSUPPORT-90	Concrete anchorage incl. ⁽²⁾ INGROUNDANCHORTYPE1	Mobile tile base incl. ⁽³⁾ TILEBASESTD-L-ALU
PFDUO270NEO-COLOUR	2,7 m / 8'10"	Solidum	\$ 5 588	\$ 5 945	\$ 7 232
PFDUO270NEO-COLOUR	2,7 m / 8'10"	Colorum	\$ 6 091	\$ 6 448	\$ 7 736
PFDUO300NEO-COLOUR	3 m / 9'10"	Solidum	\$ 6 095	\$ 6 452	\$ 7 740
PFDUO300NEO-COLOUR	3 m / 9'10"	Colorum	\$ 6 728	\$ 7 084	\$ 8 372

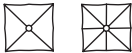
PARAFLEX SQUARE					
PRICE 2 X frame + 2 x canopy + 2 x NEO arm + multi pole & support + 2 x protection cover					
	Dimension	Fabric	Round support incl. ⁽¹⁾ UM-ROUNDSUPPORT-90	Concrete anchorage incl. ⁽²⁾ INGROUNDANCHORTYPE1	Mobile tile base incl. ⁽³⁾ TILEBASESTD-L-ALU
PFDUO200NEO-COLOUR	2 m / 6'6.7"	Solidum	\$ 5 417	\$ 5 774	\$ 7 062
PFDUO200NEO-COLOUR	2 m / 6'6.7"	Colorum	\$ 5 885	\$ 6 242	\$ 7 530
PFDUO230NEO-COLOUR	2,3 m / 7'6.6"	Solidum	\$ 6 210	\$ 6 567	\$ 7 854
PFDUO230NEO-COLOUR	2,3 m / 7'6.6"	Colorum	\$ 6 867	\$ 7 224	\$ 8 511



PARAFLEX MULTI 4

PARAFLEX ROUND					
PRICE 4 X frame + 4 x canopy + 4 x NEO arm + multi pole & support + 4 x protection cover					
	Dimension	Fabric	Round support incl. ⁽¹⁾ UM-ROUNDSUPPORT-90	Concrete anchorage incl. ⁽²⁾ INGROUNDANCHORTYPE1	Mobile tile base incl. ⁽³⁾ TILEBASESTD-L-ALU
PFMULTI270NEO-COLOUR	2,7 m / 8'10"	Solidum	\$ 9 889	\$ 10 246	\$ 11 534
PFMULTI270NEO-COLOUR	2,7 m / 8'10"	Colorum	\$ 10 896	\$ 11 253	\$ 12 540
PFMULTI300NEO-COLOUR	3 m / 9'10"	Solidum	\$ 10 904	\$ 11 261	\$ 12 549
PFMULTI300NEO-COLOUR	3 m / 9'10"	Colorum	\$ 12 169	\$ 12 526	\$ 13 813

PARAFLEX SQUARE					
PRICE 4 X frame + 4 x canopy + 4 x NEO arm + multi pole & support + 4 x protection cover					
	Dimension	Fabric	Round support incl. ⁽¹⁾ UM-ROUNDSUPPORT-90	Concrete anchorage incl. ⁽²⁾ INGROUNDANCHORTYPE1	Mobile tile base incl. ⁽³⁾ TILEBASESTD-L-ALU
PFMULTI200NEO-COLOUR	2 m / 6'6.7"	Solidum	\$ 9 548	\$ 9 905	\$ 11 192
PFMULTI200NEO-COLOUR	2 m / 6'6.7"	Colorum	\$ 10 484	\$ 10 841	\$ 12 128
PFMULTI230NEO-COLOUR	2,3 m / 7'6.6"	Solidum	\$ 11 133	\$ 11 490	\$ 12 777
PFMULTI230NEO-COLOUR	2,3 m / 7'6.6"	Colorum	\$ 12 448	\$ 12 804	\$ 14 092

Note: for a Paraflex multi 5 configuration you do not need an additional arm, just a frame, canopy and pole top (+ protection cover)

Attention: To reduce its ecological footprint, Umbrosa no longer includes the tiles with the bases. We recommend our customers to source those locally.
TILEBASE = frame + cover + wheels – tiles not included





⁽¹⁾ Fixation on hard ground

⁽²⁾ Fixation in soft ground





⁽³⁾ Use on mobile parasol base

PARAFLEX STANDARD

MOUNTING OPTIONS

		Description	Price excl. sales taxes
PFARM-NEO		Paraflex Neo arm 6'6.7", wall mount (34 x 9 cm) and bolts included, contemporary design made of anodised aluminum - clean design.	\$ 996
PFMONOPOLE-220		Single pole made of anodised aluminum - to be used with one umbrella holder.	\$ 544
PFMULTIPOLE-230		Multi pole suitable for the fixation of two, three or four umbrella holders and one extra umbrella (with poletop).	\$ 1 020
PFPOLETOP-MULTIPOLE		Poletop to install 5th Paraflex on a multi pole.	\$ 119

MOUNTING OPTIONS AND BASES

		Description	Price excl. sales taxes
Hard ground		Round support straight 90° to install the MONO pole on a hard ground (concrete - wood) or on an Umbrosa base. Support is included in the Paraflex mono set (not included with the individual monopole).	\$ 266
ROUNDSUPPORTTYPE1			
UM-ROUNDSUPPORT-90		Round support straight 90° to install the MULTI pole on a hard ground (concrete - wood) or on an Umbrosa base. Support is included in the Paraflex duo or multi set (not included with the individual multipole).	\$ 266
Soft ground		Concrete anchorage straight 90° to install the pole in a "soft" ground pouring concrete. Used in combination with the support.	\$ 357
INGROUNDANCHORTYPE1			
Tile base		Mobile large tile base set: tile base + cover + wheels in galvanized steel - 17,5 kg - 35" x 35" x 8.7" - cover ALU. Tiles not included.	\$ 1 644
TILEBASESTD-L-ALU			

PARAFLEX STANDARD

REPLACEMENT CANOPIES - FRAMES - COMPONENTS

	Component	Shape	Dimension	Fabric	Price excl. sales taxes
PFCOVER270-COLOUR	CANOPY	ROUND	8'10"	Solidum	\$ 590
PFCOVER270-COLOUR				Colorum	\$ 840
PFCOVER300-COLOUR			9'10"	Solidum	\$ 694
PFCOVER300-COLOUR				Colorum	\$ 1011
PFCOVER200-COLOUR		SQUARE	6'6.7"	Solidum	\$ 532
PFCOVER200-COLOUR				Colorum	\$ 765
PFCOVER230-COLOUR			7'6.6"	Solidum	\$ 900
PFCOVER230-COLOUR				Colorum	\$ 1 230
PFFRAME270	FRAME	ROUND	8'10"		\$ 421
PFFRAME300			9'10"		\$ 570
PFFRAME200		SQUARE	6'6.7"		\$ 393
PFFRAME230			7'6.6"		\$ 421
PFRIB270-PART	SPARE RIB		8'10"		\$ 161
PFRIB200-PART			6'6.7"		\$ 161
PFRIB300-PART			9'10"		\$ 161
PFRIB230-SHORT-PART			7'6.6" short		\$ 161
PFRIB230-LONG-PART			7'6.6" long		\$ 161
PFG RIP-NEOPART	GRIP FOR NEO ARM				\$ 129
PFP PROTECTION	Cover bag one size! Fits all Paraflex models - stick included - the cover needs to be folded for smaller models. Material: Polyester.				\$ 192



PARAFLEX UX

Production lead time: 4 weeks



PARAFLEX WALL

Price frame + canopy + NEO arm Black (RAL 9005) + protection cover		
	Dimension	Price excl. sales taxes
PFWALL200NEOBLACK_UX	6'6.7"	\$ 2 723
PFWALL230NEOBLACK_UX	7'6.6"	\$ 3 280

Paraflex UX combination

Material	
Canopy	Frame
Black	RAL9005 Black

Prices for replacement canopies, see standard collection.

PROTECTION COVER

	Description	Price excl. sales taxes
PFPROTECTION_UX	Cover bag Flanelle with fiberglass stick.	\$ 375



PARAFLEX PX

Production lead time: 4 weeks

CHOOSE YOUR COMBINATION (ARM + FRAME ALWAYS FULL BLACK, RAL 9005)

1. SHAPE

6'6.7" x 6'6.7" or 7'6.6" x 7'6.6"

2. CANOPY COLOR

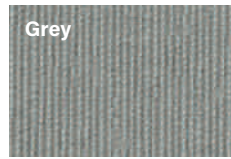
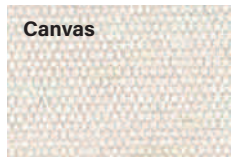

<input checked="" type="checkbox"/>	6'6.7" x 6'6.7"	PFCOVER200-NATURAL	PFCOVER200-CANVAS	PFCOVER200-GREY	PFCOVER200-TAUPE
<input checked="" type="checkbox"/>	7'6.6" x 7'6.6"	PFCOVER230-NATURAL	PFCOVER230-CANVAS	PFCOVER230-GREY	PFCOVER230-TAUPE

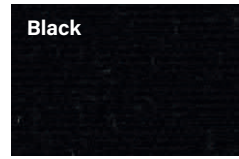
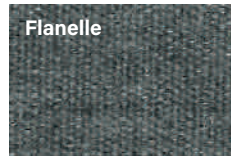

<input checked="" type="checkbox"/>	6'6.7" x 6'6.7"	PFCOVER200-MARBLE	PFCOVER200-SAND	PFCOVER200-FLANELLE	PFCOVER200-BLACK
<input checked="" type="checkbox"/>	7'6.6" x 7'6.6"	PFCOVER230-MARBLE	PFCOVER230-SAND	PFCOVER230-FLANELLE	PFCOVER230-BLACK

Price frame + canopy + NEO arm Black (RAL 9005) + protection cover		
	Dimension	Price excl. sales taxes
PX model	6'6.7" x 6'6.7"	\$ 2 723
PX model	7'6.6" x 7'6.6"	\$ 3 280

Prices for replacement canopies, see standard collection.

Price for the protection cover, see UX collection.

PARAFLEX STANDARD

PARAFLEX UX

PARAFLEX PX

NEO

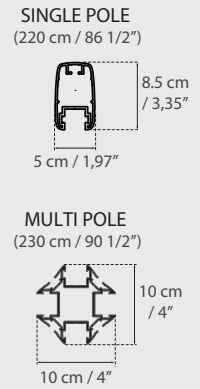
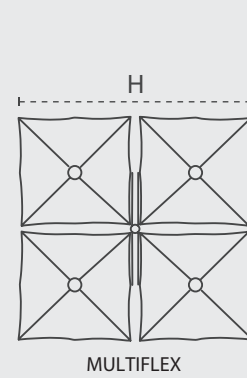
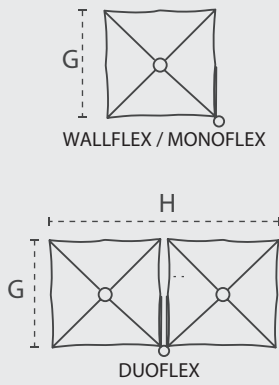
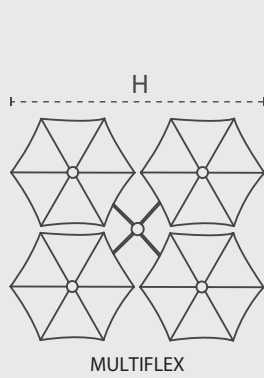
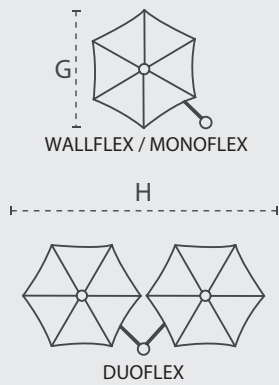
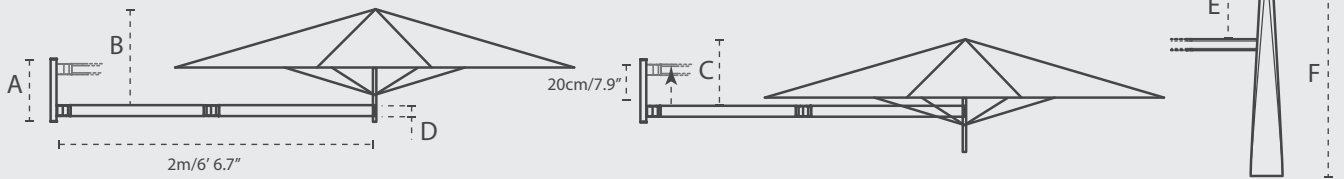

	$\pm 2\%$ -----	A cm/inch	B cm/ft	C cm/ft	D cm/inch	E cm/ft	F cm/ft	G cm/ft	H cm/ft
	2.7m/8' 10.3"	34/13.4"	70/2' 3.5"	45/1' 6"	6/2.4"	50/1' 7.7"	135/4' 5"	270/8' 10.3"	540/17' 8.6"
	3m/9' 10"	34/13.4"	70/2' 3.5"	45/1' 6"	6/2.4"	50/1' 7.7"	150/4' 11"	300/9' 10"	600/19' 8"
	2.0m/6' 6.7"	34/13.4"	70/2' 3.5"	45/1' 6"	6/2.4"	50/1' 7.7"	135/4' 5"	200/6' 6.7"	400/13' 1.5"
	2.3m/7' 6.6"	34/13.4"	53/1' 8.9"	45/1' 6"	6/2.4"	40/1' 3.7"	163/5' 4"	230/7' 7"	460/15' 1"

SPECTRA

CONCEPT



Quick access to full
technical data sheet

Step into the world of the Spectra cantilever umbrella, a true master of versatility. With its unique shape, this cantilever umbrella offers an endless range of positions. The sleek design effortlessly combines beauty with functionality thanks to its innovative fan system. Instead of closing vertically, the umbrella closes horizontally. A revolutionary and contemporary concept that is unmatched.

DESIGNER

Dirk Wynants

USP

The very first truly beautiful, elegant and functional parasol.

SELLING POINTS

- Very wind resistant thanks to the fiberglass ribs
- 180° fan system, easy to open and close
- The canopy can be fixed in different positions according to the position of the sun
- Pole rotates 360° around its axis.
- Spectra "forward (80°)" creates space between base and furniture.

VERSIONS

SPECTRA STANDARD



RAL 9005

RAL 1013



STRAIGHT 90°

8'2" x 8'2"
9'10" x 9'10"

From \$ 4 655



FORWARD 80°

8'2" x 8'2"
9'10" x 9'10"

From \$ 4 655



DUO

8'2" x 17'9"

From \$ 10 135



MULTI

17'9" x 17'9"

From \$ 20 259

QUICK SHIP

PRODUCTION TIME, COLORS AND MODELS												
SPECTRA COLOR	SOLIDUM				COLORUM							
	Natural	Canvas	Grey	Taupe	Marble	Mint	Blush	Pepper	Almond	Sand	Flanelle	Black
SPECTRA SQUARE	QS	QS	QS	4	4	4	4	4	4	4	4	4
SPECTRA DUO/MULTI	QS	QS	QS	4	4	4	4	4	4	4	4	4

QS = 8 working days / 4 = 4 weeks production time



SPECTRA STANDARD

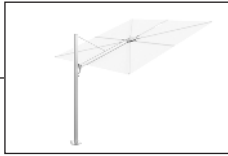

SPECTRA FORWARD AND STRAIGHT | ALU | 8,2"

PRICE ALU frame + canopy + round support + protection cover

	Pole	Fabric	⁽¹⁾	Concrete anchorage incl. ⁽²⁾ INGROUNDANCHORTYPE1	Mobile base incl. ⁽³⁾ TILEBASESTD-L-ALU
SP250ALUN80F-COLOUR	80°	Solidum	\$ 4 655	\$ 5 012	\$ 6 299
SP250ALUN90S-COLOUR	90°				
SP250ALUN80F-COLOUR	80°	Colorum	\$ 4 836	\$ 5 193	\$ 6 480
SP250ALUN90S-COLOUR	90°				



SPECTRA FORWARD AND STRAIGHT | BLACK | 8,2"

PRICE BLACK frame (RAL 9005) + canopy + round support + protection cover

	Pole	Fabric	⁽¹⁾	Concrete anchorage incl. ⁽²⁾ INGROUNDANCHORTYPE1	Mobile base incl. ⁽³⁾ TILEBASESTD-L-BLACK
SP250BLACKN80F-COLOUR	80°	Solidum	\$ 5 305	\$ 5 661	\$ 7 097
SP250BLACKN90S-COLOUR	90°				
SP250BLACKN80F-COLOUR	80°	Colorum	\$ 5 486	\$ 5 842	\$ 7 278
SP250BLACKN90S-COLOUR	90°				



SPECTRA FORWARD AND STRAIGHT | BEIGE LIMESTONE | 8,2"

PRICE BEIGE LIMESTONE frame (RAL 1013) + canopy + round support + protection cover

	Pole	Fabric	⁽¹⁾	Concrete anchorage incl. ⁽²⁾ INGROUNDANCHORTYPE1	Mobile base incl. ⁽³⁾ TILEBASESTD-L-LIME
SP250LIMEN80F-COLOUR	80°	Solidum	\$ 5 305	\$ 5 661	\$ 7 097
SP250LIMEN90S-COLOUR	90°				
SP250LIMEN80F-COLOUR	80°	Colorum	\$ 5 486	\$ 5 842	\$ 7 278
SP250LIMEN90S-COLOUR	90°				

⁽¹⁾ Fixation on hard ground

⁽²⁾ Fixation in soft ground

⁽³⁾ Use on mobile parasol base

For easy mounting, order spacer in addition!

SPECTRA STANDARD

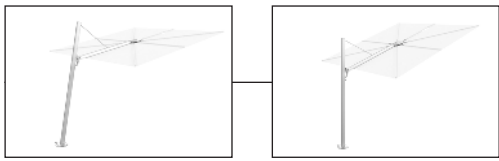

SPECTRA FORWARD AND STRAIGHT | ALU | 9'10"

PRICE ALU frame + canopy + round support + protection cover					
	Pole	Fabric	⁽¹⁾	Concrete anchorage incl. ⁽²⁾ INGROUNDANCHORTYPE1	Mobile base incl. ⁽³⁾ TILEBASESTD-L-ALU
SP300ALUN80F-COLOUR	80°	Solidum	\$ 5 562	\$ 5 919	\$ 7 354
SP300ALUN90S-COLOUR	90°				
SP300ALUN80F-COLOUR	80°	Colorum	\$ 5 971	\$ 6 327	\$ 5 971
SP300ALUN90S-COLOUR	90°				

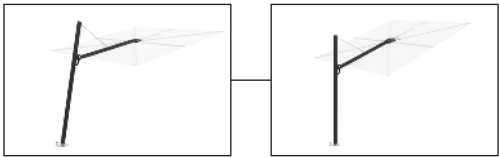

SPECTRA FORWARD AND STRAIGHT | BLACK | 9'10"

PRICE BLACK frame (RAL 9005) + canopy + round support + protection cover					
	Pole	Fabric	⁽¹⁾	Concrete anchorage incl. ⁽²⁾ INGROUNDANCHORTYPE1	Mobile base incl. ⁽³⁾ TILEBASESTD-L-BLACK
SP300BLACKN80F-COLOUR	80°	Solidum	\$ 6 331	\$ 6 688	\$ 8 123
SP300BLACKN90S-COLOUR	90°				
SP300BLACKN80F-COLOUR	80°	Colorum	\$ 6 740	\$ 7 097	\$ 8 532
SP300BLACKN90S-COLOUR	90°				

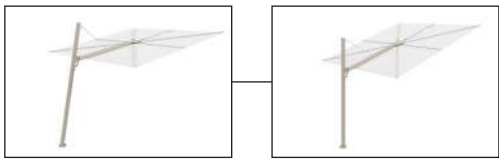

SPECTRA FORWARD AND STRAIGHT | BEIGE LIMESTONE | 9'10"

PRICE BEIGE LIMESTONE frame (RAL 1013) + canopy + round support + protection cover					
	Pole	Fabric	⁽¹⁾	Concrete anchorage incl. ⁽²⁾ INGROUNDANCHORTYPE1	Mobile base incl. ⁽³⁾ TILEBASESTD-L-LIME
SP300LIMEN80F-COLOUR	80°	Solidum	\$ 6 331	\$ 6 688	\$ 8 123
SP300LIMEN90S-COLOUR	90°				
SP300LIMEN80F-COLOUR	80°	Colorum	\$ 6 740	\$ 7 097	\$ 8 532
SP300LIMEN90S-COLOUR	90°				

⁽¹⁾ Fixation on hard ground

⁽²⁾ Fixation in soft ground

⁽³⁾ Use on mobile parasol base

For easy mounting, order spacer in addition!

SPECTRA STANDARD

STRAIGHT -90°

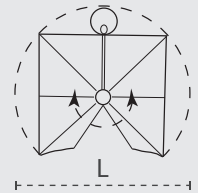
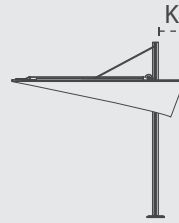
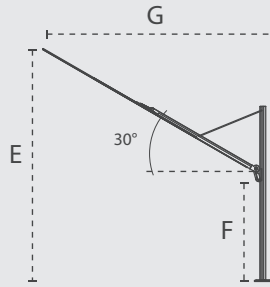
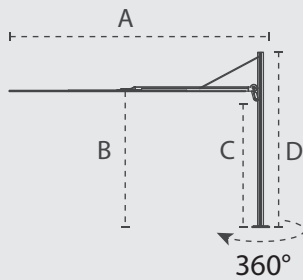

FORWARD -80°

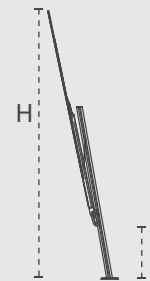
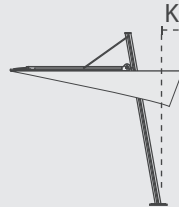
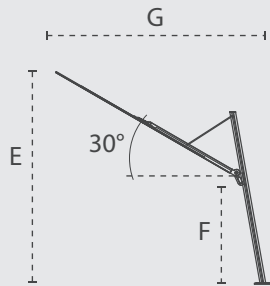
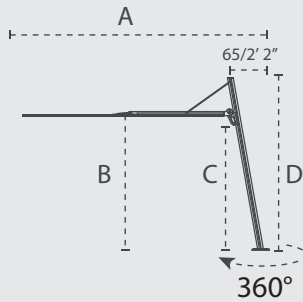

	A cm/ft	B cm/ft	C cm/ft	D cm/ft	E cm/ft	F cm/ft	G cm/ft	H cm/ft	I cm/ft	J cm/ft	K cm/ft	L cm/ft
±/- 2% +-----+ Straight 2.5m/8' 2"	295/9' 8"	200/6' 7"	185/6' 1"	260/8' 7"	270/8' 10.3"	135/4' 5"	240/7' 10.5"	360/11' 10"	90/2' 11"	260/8' 7"	35/1' 1.8"	370/12' 2"
3m/9' 10"	345/11' 4"	205/6' 9"	185/6' 1"	260/8' 7"	280/9' 2"	140/4' 7"	250/8' 2.4"	400/13' 2"	80/2' 8"	270/8' 10"	50/1' 7.7"	435/14' 3"
Forward 2.5m/8' 2"	330/10' 10"	195/6' 5"	180/5' 11"	255/8' 8"	270/8' 10.3"	135/4' 5"	305/10'	350/11' 6"	90/2' 11"	260/8' 7"	0/0"	370/12' 2"
3 m/9' 10"	380/12' 6"	195/6' 5"	180/5' 11"	255/8' 8"	280/9' 2"	140/4' 7"	315/10' 4"	390/12' 10"	80/2' 8"	260/8' 7"	5/ 1.97"	435/14' 3"

Attention: To reduce its ecological footprint, Umbrosa no longer includes the tiles with the bases. We recommend our customers to source those locally.
 TILEBASE = frame + cover + wheels - tiles not included



DUO SPECTRA | ALU | 8'2" X 17'9"

PRICE 2 X ALU frame + 2 x canopy + round support + protection cover				
	Fabric	(1)	Concrete anchorage incl. (2) INGROUNDANCHORTYPE1	Mobile base incl. (3) TILEBASESTD-L-ALU
SPDUOALUN-COLOUR	Solidum	\$ 10 135	\$ 10 492	\$ 11 779
SPDUOALUN-COLOUR	Colorum	\$ 10 440	\$ 10 796	\$ 12 084

(1) Fixation on hard ground (2) Fixation in soft ground (3) Use on mobile parasol base
 For easy mounting, order spacer in addition!

SPECTRA STANDARD



DUO SPECTRA | BLACK | 8'2" X 17'9"

PRICE 2 X **BLACK** frame (RAL 9005) + 2 x canopy + round support + protection cover

	Fabric	⁽¹⁾	Concrete anchorage incl. ⁽²⁾ INGROUNDANCHORTYPE1	Mobile tile base incl. ⁽³⁾ TILEBASESTD-L-BLACK
SPDUOBLACKN-COLOUR	Solidum	\$ 11 462	\$ 11 819	\$ 13 255
SPDUOBLACKN-COLOUR	Colorum	\$ 11 768	\$ 12 125	\$ 13 560



DUO SPECTRA | BEIGE LIMESTONE | 8'2" X 17'9"

PRICE 2 X **BEIGE LIMESTONE** frame (RAL 1013) + 2 x canopy + round support + protection cover

	Fabric	⁽¹⁾	Concrete anchorage incl. ⁽²⁾ INGROUNDANCHORTYPE1	Mobile tile base incl. ⁽³⁾ TILEBASESTD-L-LIME
SPDUOLIMEN-COLOUR	Solidum	\$ 11 462	\$ 11 819	\$ 13 255
SPDUOLIMEN-COLOUR	Colorum	\$ 11 768	\$ 12 125	\$ 13 560

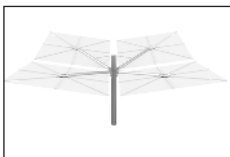

MULTI SPECTRA | ALU | 17'9" X 17'9"

PRICE 4 X **ALU** frame + 4 x canopy + support + protection cover

	Fabric	⁽¹⁾	Concrete anchorage incl. ⁽²⁾ INGROUNDANCHORTYPE1	Mobile tile base incl. ⁽³⁾ TILEBASESTD-L-ALU
SPMULALUN-COLOUR	Solidum	\$ 20 259	\$ 20 616	\$ 21 903
SPMULALUN-COLOUR	Colorum	\$ 20 869	\$ 21 225	\$ 22 513



MULTI SPECTRA | BLACK | 17'9" X 17'9"

PRICE 4 X **BLACK** frame (RAL 9005) + 4 x canopy + support + protection cover

	Fabric	⁽¹⁾	Concrete anchorage incl. ⁽²⁾ INGROUNDANCHORTYPE1	Mobile tile base incl. ⁽³⁾ TILEBASESTD-L-BLACK
SPMULBLACKN-COLOUR	Solidum	\$ 22 912	\$ 23 269	\$ 24 705
SPMULBLACKN-COLOUR	Colorum	\$ 23 523	\$ 23 880	\$ 25 315

⁽¹⁾ Fixation on hard ground

⁽²⁾ Fixation in soft ground

⁽³⁾ Use on mobile parasol base

For easy mounting, order spacer in addition!

SPECTRA STANDARD



MULTI SPECTRA | BEIGE LIMESTONE | 17'9" X 17'9"

PRICE 4 X BEIGE LIMESTONE frame (RAL 1013) + 4 x canopy + support + protection cover				
	Fabric	⁽¹⁾	Concrete anchorage incl. ⁽²⁾ INGROUNDANCHORTYPE1	Mobile tile base incl. ⁽³⁾ TILEBASESTD-L-LIME
SPMULTILIMEN-COLOUR	Solidum	\$ 22 912	\$ 23 269	\$ 24 705
SPMULTILIMEN-COLOUR	Colorum	\$ 23 523	\$ 23 880	\$ 25 315

+/- 2% -----	A	B	C	D	E	F	G	J	I	M	M'	N	N'
	cm/ft	cm/ft	cm/ft	cm/ft	cm/ft	cm/ft	cm/ft	cm/ft	cm/ft	cm/ft	cm/ft	cm/ft	cm/ft
Spectra Duo	253/8' 4"	197/6' 6"	187/6' 2"	260/8' 7"	340/11' 2"	135/4' 5"	210/6' 10.7"	270/8' 10"	50/1' 7.7"	540/17' 9"	644/21' 2"	285/9' 4"	337/11' 1"
Spectra Multi	253/8' 4"	197/6' 6"	187/6' 2"	260/8' 7"	340/11' 2"	140/4' 7"	210/6' 10.7"	270/8' 10"	50/1' 7.7"	540/17' 9"	644/21' 2"	540/17' 9"	644/21' 2"

Attention: To reduce its ecological footprint, Umbrosa no longer includes the tiles with the bases. We recommend our customers to source those locally.

TILEBASE = frame + cover + wheels - tiles not included

⁽¹⁾ Fixation on hard ground







⁽²⁾ Fixation in soft ground

⁽³⁾ Use on mobile parasol base

For easy mounting, order spacer in addition!

SPECTRA STANDARD

MOUNTING OPTIONS AND BASES

		Description	Finish	Price excl. sales taxes
Hard ground		When you want to install the umbrella on a solid surface, it is recommended to order a spacer so that you don't have to make a cutout in the surface.	HDPE	\$ 129
SPACER1				
Soft ground		Concrete anchorage to install the pole in a "soft" ground pouring concrete. To use in combination with a round support.	Galvanized steel	\$ 357
INGROUNDANCHORTYPE1				
Extension kit		Spectra extension kit 5.9" - to increase the height - heavy duty piece included. The extension kit is recommended for installation of the pole direct to the floor or in the ground, not for installation on a tile base (max. 2 pieces).	Alu	\$ 236
SPEXTKIT-ALUN				
SPEXTKIT-BLACKN			Black (RAL 9005)	\$ 290
SPEXTKIT-LIMEN			Beige limestone (RAL 1013)	\$ 290
Mobile bases		Large standaard tile base: base - cover - wheels in galvanized steel - 38.58 lbs (add at least 396 lbs of weight with tiles) - 35" x 35" x 8.7". Tiles not included.	Cover: Alu	\$ 1 644
TILEBASESTD-L-ALU				
TILEBASESTD-L-BLACK			Cover: Black (RAL 9005)	\$ 1 792
TILEBASESTD-L-LIME		Cover: Beige Limestone (RAL 1013)	\$ 1 792	

REPLACEMENT CANOPIES AND COVER BAGS

	Dimensions	Fabric	Price excl. sales taxes
SP250COVERN-COLOUR	8'2" x 8'2"	Solidum	\$ 1 562
SP250COVERN-COLOUR		Colorum	\$ 1 743
SP300COVERN-COLOUR	9'10" x 9'10"	Solidum	\$ 1 899
SP300COVERN-COLOUR		Colorum	\$ 2 308
SPDUOMULCOVERN-COLOUR	DUO / MULTI	Solidum	\$ 1 906
SPDUOMULCOVERN-COLOUR		Colorum	\$ 2 057
SPPROTECTION	8'2" and 9'10"	Cover bag in polyester with fiberglass stick.	\$ 243
SPDUO-PROTECTION	DUO		\$ 520
SPMULTI-PROTECTION	MULTI		\$ 520

ICARUS

CONCEPT



Quick access to full technical data sheet



With the Icarus, Umbrosa hits two birds with one stone. Inspired by nature, we have designed an umbrella that also serves as a windscreen. The Icarus embraces and protects. It creates the safe shelter of a cocoon while allowing you to fully enjoy the beautiful weather.

DESIGNER

Umbrosa design team

USP

The only parasol that can also be used as a windshield and that creates the ultimate cocoon with its unique and natural shape.

SELLING POINTS

- Extremely wind resistant parasol
- Large shaded area thanks to 360° rotation and height adjustment of the parasol
- Easy to use and ergonomic
- Cosy cocoon

VERSIONS

ICARUS STANDARD

ALU



9'10"
From \$ 6 242

ICARUS UX

BEIGE LIMESTONE

RAL 1013



SAND
From \$ 8 543

ICARUS PX

BEIGE LIMESTONE

RAL 1013



ICARUS PX
From \$ 8 543

Icarus PX freely combinable:
1 size, 1 frame color, 8 fabric colors

NEW

CANOPY COLORS

Black 	Marble 	Canvas 	Natural
Flanelle 	Sand 	Grey 	Taupe



ICARUS STANDARD

QUICK SHIP

PRODUCTION TIME, COLORS AND MODELS

ICARUS COLOR	SOLIDUM				COLORUM							
	Natural	Canvas	Grey	Taupe	Marble	Mint	Blush	Pepper	Almond	Sand	Flanelle	Black
ICARUS 9'10" X 9'10"	QS	4	4	4	4	4	4	4	4	4	4	4

QS = 8 working days / 4 = 4 weeks production time



ICARUS | ALU | 9'10"

PRICE ALU frame + canopy + round support + protection cover

	Fabric	(1)	Concrete anchorage incl. (2) INGROUNDANCHORTYPE1	Mobile base incl. (3) TILEBASESTD-L-ALU
ICARUS2N-COLOUR	Solidum	\$ 6 242	\$ 6 599	\$ 7 886
ICARUS2N-COLOUR	Colorum	\$ 6 532	\$ 6 889	\$ 8 176

MOUNTING OPTIONS AND BASES

		Description	Finish	Price excl. sales taxes
Hard ground		When you want to install the umbrella on a solid surface, it is recommended to order a spacer so that you don't have to make a cutout in the surface.	HDPE	\$ 129
SPACER1				
Soft ground		Concrete anchorage to install the pole in a "soft" ground pouring concrete. To use in combination with a round support.	Galvanized steel	\$ 357
INGROUNDANCHORTYPE1				
Mobile base		Large standaard tile base ALU: base-cover-wheels - galvanized steel - 38.58 lbs (add at least 396 lbs of weight with tiles) - 35" x 35" x 8.7". Tiles not included.	Cover: Alu	\$ 1 644
TILEBASESTD-L-ALU				

REPLACEMENT CANOPIES AND COVER BAG

	Fabric	Price excl. sales taxes
ICARUSCOVER2N-COLOUR	Solidum	\$ 1 741
ICARUSCOVER2N-COLOUR	Colorum	\$ 2 048
ICARUSPROTECTION	Cover bag in polyester with fiberglass stick.	\$ 272

(1) Fixation on hard ground

(2) Fixation in soft ground

(3) Use on mobile parasol base

For easy mounting, order spacer in addition!



ICARUS UX

Production lead time: 4 weeks



PRICE frame + canopy + support + protection cover					
	Dimension	(1)	Concrete anchorage incl. (2) INGROUNDANCHORTYPE1	Mobile base incl. (3)	
ICARUSSAND2N_UX	9'10"	\$ 8 543	\$ 8 899	\$ 11 508	TILEBASEUX-LSAND

Icarus UX combination

Material		
Canopy	Frame + Base	Cover base *
 <p style="font-size: 8px;">Sand</p>	 <p style="font-size: 8px;">RAL 1013 Beige Limestone</p>	 <p style="font-size: 8px;">Thermo Poplar</p>

SAND

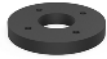
MOUNTING OPTIONS AND BASES

		Description	Finish	Price excl. sales taxes
Hard ground		When you want to install the umbrella on a solid surface, it is recommended to order a spacer so that you don't have to make a cutout in the surface.	HDPE	\$ 139
SPACER1				
Soft ground		Concrete anchorage to install the pole in a "soft" ground pouring concrete. To use in combination with a round support.	Galvanized steel	\$ 357
INGROUNDANCHORTYPE1				
Mobile bases		Mobile large UX base set: base-cover (Thermo poplar) - wheels 70.55 lbs (add at least 396 lbs of weight with tiles) - 35" x 35" x 8.7" (Sand), Tiles not included.	Sand - RAL 1013 Beige Limestone. Cover in wood (Thermo Poplar)*.	\$ 2 965
TILEBASEUX-L-SAND				

* Our UX wooden covers are made of thermotreated poplar wood that has not been treated for color stability. The wood will weather with outdoor exposure and turn grey.

⁽¹⁾ Fixation on hard ground

⁽²⁾ Fixation in soft ground

⁽³⁾ Use on mobile parasol base

For easy mounting, order spacer in addition!

ICARUS UX

PROTECTION COVER

	Description	Price excl. sales taxes
ICPROTECTION_UX	Cover bag Flanelle with fiberglass stick	\$ 495

Price for the protection cover, see UX collection.

ICARUS PX

Production lead time: 4 weeks

NEW

CHOOSE YOUR COMBINATION

QR code to spec sheet



1. FRAME COLOR

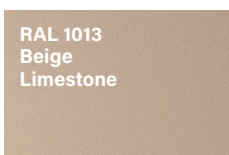

ICFRAMELIME_UX

2. CANOPY COLOR

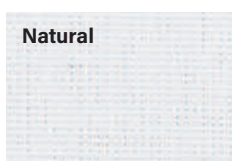

ICARUSCOVER2N-NATUR

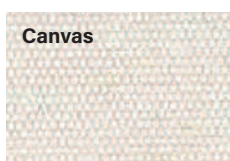

ICARUSCOVER2N-CANV

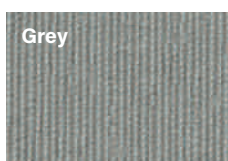

ICARUSCOVER2N-GREY



ICARUSCOVER2N-TAUPE

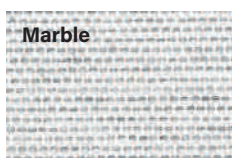

ICARUSCOVER2N-MARB

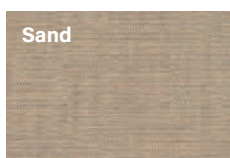

ICARUSCOVER2N-SAND



ICARUSCOVER2N-FLANE

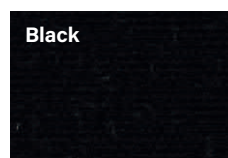

ICARUSCOVER2N-BLACK

ICARUS PX

4. BASE

A. Top plate



RAL1013
Beige Limestone
LIMEBASETOPPLATEUX



Thermo
Poplar *
WOODBASETOPPLATEUX

B. Frame base



RAL1013
Beige Limestone
LIMEBASEFRAMEUX

PRICE PX frame + canopy + support + protection cover				
	Dimension	(1)	Concrete anchorage incl. (2) INGROUNDANCHORTYPE1	Mobile base incl. (3)
ICARUS PX	9'10"	\$ 8 543	\$ 8 899	\$ 11 508

* Our UX wooden covers are made of thermotreated poplar wood that has not been treated for color stability. The wood will weather with outdoor exposure and turn grey.

Prices for replacement canopies, see standard collection. Price for the protection cover, see UX collection.

ICARUS STANDARD **ICARUS UX** **ICARUS PX**

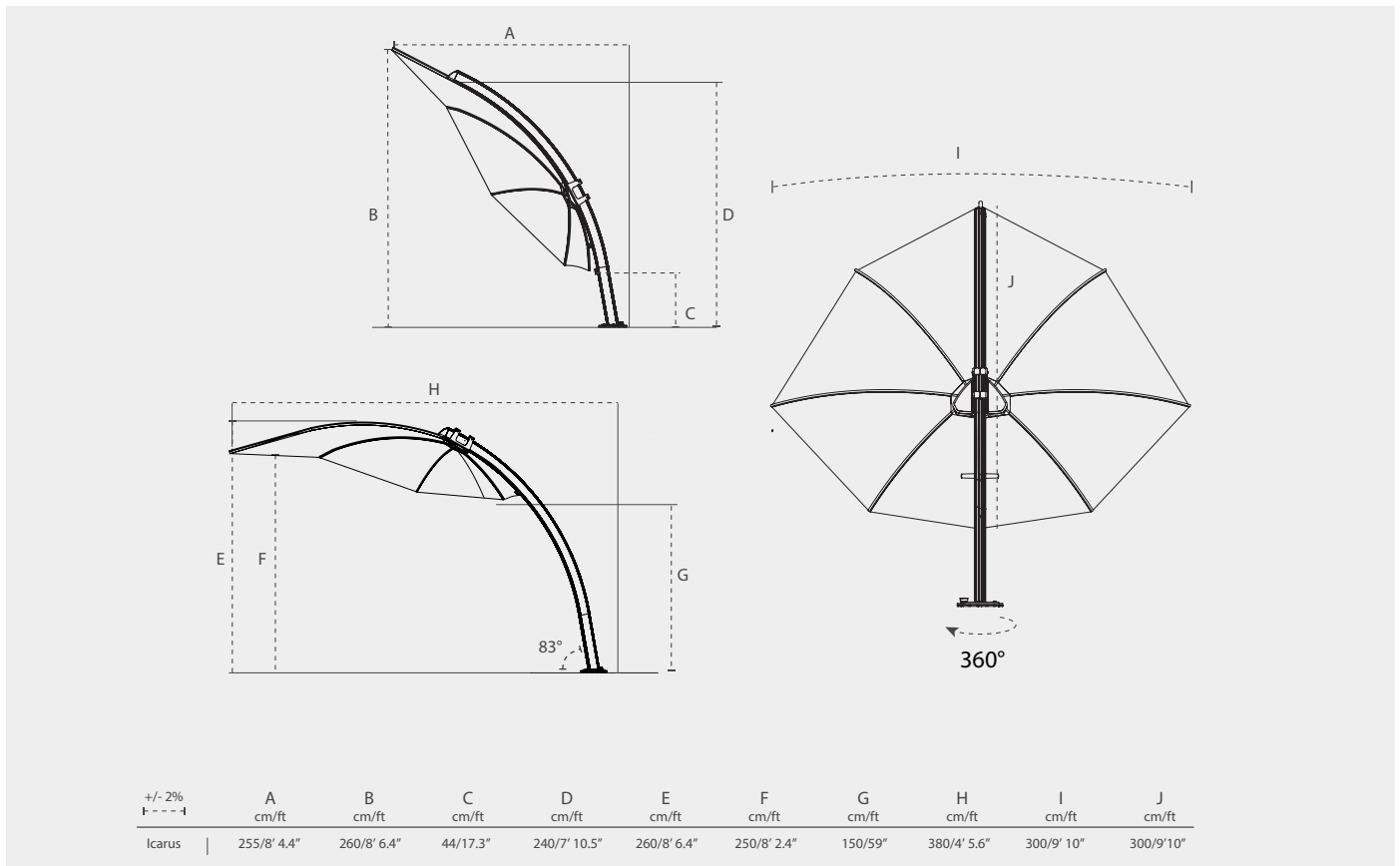

Attention: To reduce its ecological footprint, Umbrosa no longer includes the tiles with the bases. We recommend our customers to source those locally. TILEBASE = frame + cover + wheels – tiles not included

VERSA

CONCEPT

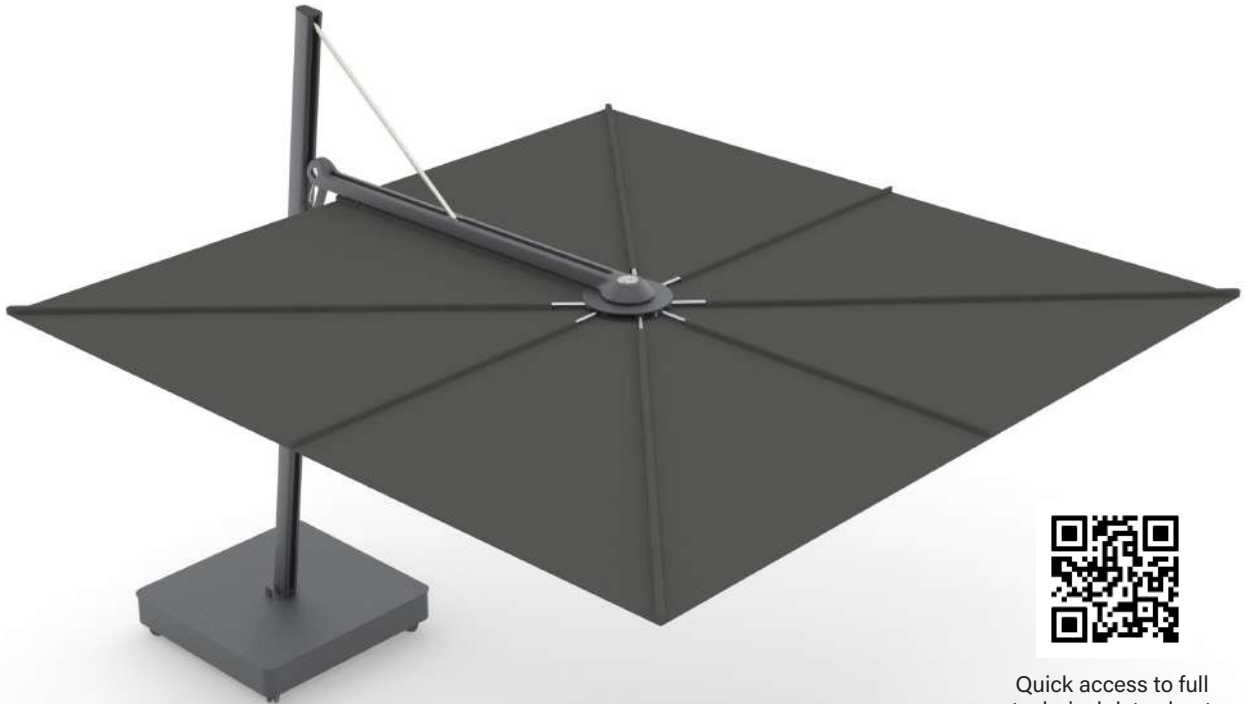

Quick access to full
technical data sheet

Outdoor trends are moving towards a real outdoor living space where everything has to be cosy, beautiful and functional at the same time. Furniture is chosen in function of the interior, the windows, the garden, the colors, etc. Parasols must also fit in perfectly. The UX collection includes five unique combinations, the PX collection allows you to compose your own parasol.

DESIGNER

Dirk Wynants and Umbrosa Design Team

USP

The impressive combination of luxury and sophistication in a robust and particularly user-friendly parasol.

SELLING POINTS

- 360° fan concept - easy to open and close
- Height adjustable with one hand
- Rotation system (360°) is nicely integrated into the elegant parasol base
- Robust and extremely wind resistant (glass fiber ribs)
- Leans slightly forward (80°) in order to create space between the furniture and base

VERSIONS

VERSA UX

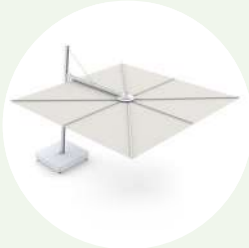

ARCHITECTURE
9'10" x 9'10"
From \$ 7 934



FULL BLACK
9'10" x 9'10"
From \$ 7 934

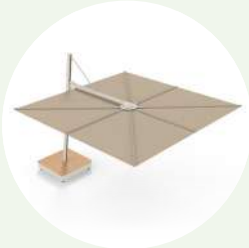

SAND
9'10" x 9'10"
From \$ 7 934



LATTE
Ø 11'6"
From \$ 7 934



SAFARI
Ø 11'6"
From \$ 7 934

VERSA PX



VERSA PX
From \$ 7 934

Versa PX freely combinable: 2 sizes, 5 frame colors, 8 fabric colors

FRAME COLORS

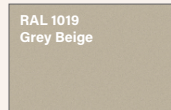
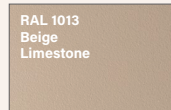
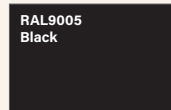
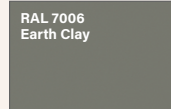

FABRIC COLORS

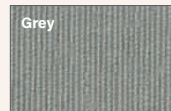
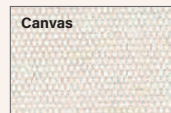
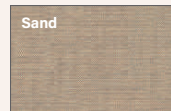
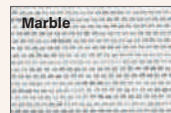
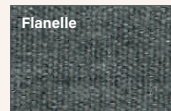
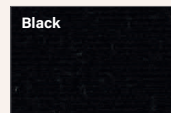





VERSA UX



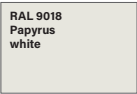
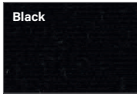
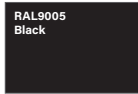

Production lead time: QS

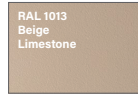
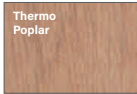
PRICE frame + canopy + support + protection cover				
	Dimension	⁽¹⁾	Concrete anchorage incl. ⁽²⁾ INGROUNDANCHORTYPE1	Mobile base incl. ⁽³⁾
VEARCHITECTURE_UX	9'10" x 9'10"	\$ 7 934	\$ 8 291	TILEBASEUX-L-ARCHI
VEFULLBLACK_UX	9'10" x 9'10"			TILEBASEUX-L-BLACK
VESAND_UX	9'10" x 9'10"			TILEBASEUX-L-SAND
VELAT350RO_UX	Ø 11'6"			TILEBASEUX-L-LATTE
VESAF350RO_UX	Ø 11'6"			TILEBASEUX-L-SAFARI

UX combinations square

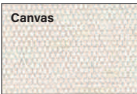
Material		Material		Material		
Canopy	Frame + Base	Canopy	Frame + Base	Canopy	Frame + Base	Cover base*
						
ARCHITECTURE		FULL BLACK		SAND		

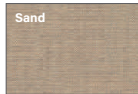
UX combinations round

Material			Material		
Canopy	Frame + Base	Cover base*	Canopy	Frame + Base	Cover base*
					
LATTE			SAFARI		

* Our UX wooden covers are made of thermotreated poplar wood that has not been treated for color stability. The wood will weather with outdoor exposure and turn grey.

REPLACEMENT CANOPIES AND PROTECTION COVER

	Description	Price excl. sales taxes
VE300SQCOVERMARB_UX	9'10" x 9'10" Marble	€ 2 383
VE300SQCOVERBLACK_UX	9'10" x 9'10" Black	
VE300SQCOVERSAND_UX	9'10" x 9'10" Sand	
VE350ROCOVERCANV_UX	Ø 11'6" Canvas	
VE350ROCOVERSAND_UX	Ø 11'6" Sand	
VEPROTECTION_UX	Cover bag Flanelle with fiberglass stick.	€ 500

⁽¹⁾ Fixation on hard ground



⁽²⁾ Fixation in soft ground

⁽³⁾ Use on mobile parasol base

For easy mounting, order spacer in addition!

VERSA UX

MOUNTING OPTIONS AND BASES

		Description	Finish	Price excl. sales taxes
Hard ground		When you want to install the umbrella on a solid surface, it is recommended to order a spacer so that you don't have to make a cutout in the surface.	HDPE	\$ 129
SPACER1				
Soft ground		Concrete anchorage to install the pole in a "soft" ground pouring concrete. To use in combination with a round support.		\$ 357
INGROUNDANCHORTYPE1				
Mobile bases		Mobile large UX tile base: base - cover - wheels - 70.55 lbs (add at least 396 lbs of weight with tiles) - 35" x 35" x 8.7" Tiles not included. (Sand, Latte, Safari: 35"x 35"x 9.45").	Papyrus White - RAL 9018	\$ 2 965
TILEBASEUX-L-ARCHI			Black - RAL 9005	
TILEBASEUX-L-BLACK			Sand - RAL 1013 Beige Limestone. Cover in wood (Thermo Poplar).	
TILEBASEUX-L-SAND			Latte - Grey Beige RAL 1019. Cover in wood (Thermo Poplar).	
TILEBASEUX-L-LATTE			Safari - Earth Clay RAL 7006. Cover in wood (Thermo Poplar).	
TILEBASEUX-L-SAFARI				

* Our UX wooden covers are made of thermotreated poplar wood that has not been treated for color stability. The wood will weather with outdoor exposure and turn grey.

EXTENSION KIT (EXTENSIONKIT)

		Description	UX version	Price excl. sales taxes
VEEXTKIT-PAPY		Versa UX extension kit 5.9" - heavy duty piece included. The extension kit is recommended for installation of the pole direct to the floor or in the ground, not for installation on a UX base.	ARCHI	\$ 306
VEEXTKIT-BLACK			FULL BLACK	
VEEXTKIT-LIME			SAND	
VEEXTKIT-GREYB			LATTE	
VEEXTKIT-EARTH			SAFARI	



VERSA PX

VERSA PX | 9'10" X 9'10" | Ø 11'6" | 80°

CHOOSE YOUR COMBINATION

1. SHAPE

SQUARE



ROUND



1. FRAME COLOR

RAL 9018
Papyrus
white

RAL9005
Black

RAL 1013
Beige
Limestone

RAL 1019
Grey Beige

RAL 7006
Earth Clay



VEFRAMEPAPY_UX

VEFRAMEBLACK_UX

VEFRAMELIME_UX

VEFRAMEGREYB_UX

VEFRAMEEARTH_UX



VEFRAME350ROPAPY_UX

VEFRAME350ROBLACK_UX

VEFRAME350ROLIME_UX

VEFRAME350ROGREYB_UX

VEFRAME350ROEARTH_UX

2. CANOPY COLOR

Natural

Canvas

Grey

Taupe



VE300COVERNAT_UX

VE300COVERCANV_UX_R

VE300COVERGREY_UX

VE300COVERTAUPE_UX



VE350ROCOVERNAT_UX

VE350ROCOVERCANV_UX

VE350ROCOVERGREY_UX

VE350ROCOVERTAUPE_UX

Marble

Sand

Flanelle

Black



VE300COVERMARB_UX

VE300COVERSAND_UX_R

VE300COVERFLAN_UX

VE300COVERBLACK_UX



VE350ROCOVERMARB_UX

VE350ROCOVERSAND_UX

VE350ROCOVERFLAN_UX

VE350ROCOVERBLACK_UX

VERSA PX

4. BASE

A. Top plate



RAL9018
Papyrus white
PAPYBASETOPPLATEUX

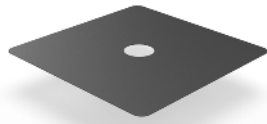

RAL9005
Black
BLACBASETOPPLATEUX



RAL1013
Beige Limestone
LIMEBASETOPPLATEUX



Thermo
Poplar*
WOODBASETOPPLATEUX

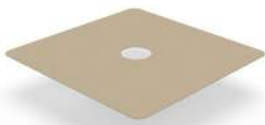

RAL1019
Grey Beige
GREYBBASETOPPLATEUX

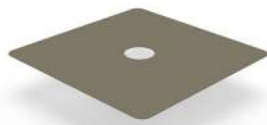

RAL7006
Earth Clay
EARTHBASETOPPLATEUX

B. Frame base



RAL 9018
Papyrus white
PAPYBASEFRAMEUX



RAL9005
Black
BLACBASEFRAMEUX



RAL1013
Beige Limestone
LIMEBASEFRAMEUX



RAL1019
Grey Beige
GREYBBASEFRAMEUX



RAL7006
Earth Clay
EARTHBASEFRAMEUX

* Our UX wooden covers are made of thermotreated poplar wood that has not been treated for color stability. The wood will weather with outdoor exposure and turn grey.

VERSA PX

PRICE PX frame + canopy + support + protection cover			
	(1)	Concrete anchorage incl. (2) INGROUNDANCHORTYPE1	Mobile base incl. (3)
Versa PX	\$ 7 934	\$ 8 291	\$ 10 899

Prices for replacement canopies, see UX collection.
Price for the protection cover, see UX collection.

HOW TO ORDER?



Choose a frame, a canopy and the two parts of the parasol base.

Example:

VEFRAMEBLACK_UX
+ VE300COVERSAND_UX_R
+ WOODBASETOPPLATEUX
+ BLACBASEFRAMEUX
= 1 PRICE FOR ALL PX MODELS
WITH PARASOL BASE

= \$ 10 899

VERSA UX/PX

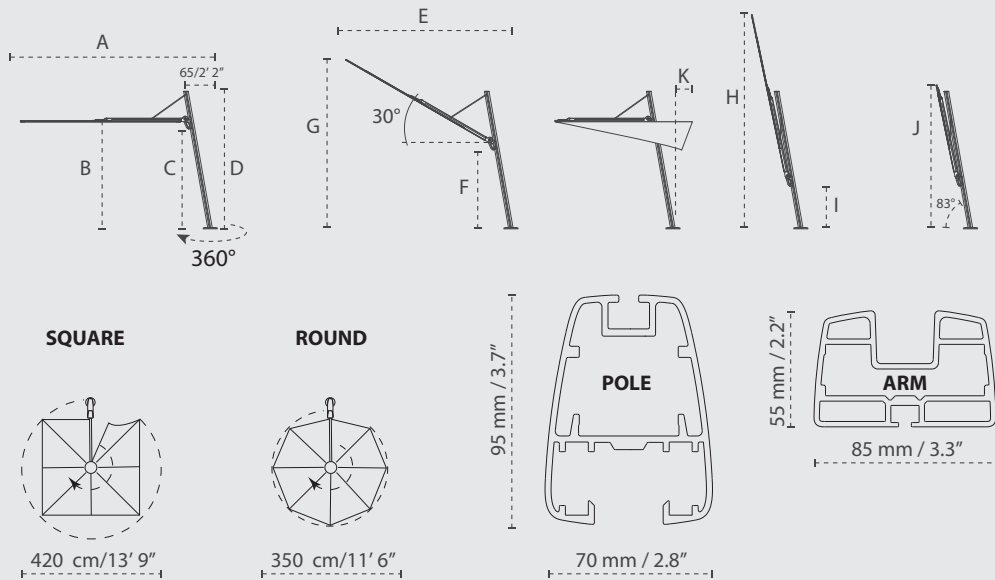

+/- 2% Tolerance		A cm/ft	B cm/ft	C cm/ft	D cm/ft	E cm/ft	F cm/ft	G cm/ft	H cm/ft	I cm/ft	J cm/ft	K cm/ft
☒	3 x 3 m / 9' 10" x 9' 10"	365/11' 12"	195/6' 5"	185/6' 1"	260/8' 6"	280/9' 2"	128/4' 2"	325/10' 8"	410/13' 5"	77/2' 6"	265/8' 8"	0/0"
☒	3,5 m / 11' 6"	380/12' 6"	195/6' 5"	185/6' 1"	260/8' 6"	295/9' 8"	128/4' 2"	340/11' 2"	425/13' 11"	77/2' 6"	280/9' 2"	0/0"

Attention: To reduce its ecological footprint, Umbrosa no longer includes the tiles with the bases. We recommend our customers to source those locally.

TILEBASE = frame + cover + wheels – tiles not included

(1) Fixation on hard ground

(2) Fixation in soft ground

(3) Use on mobile parasol base

For easy mounting, order spacer in addition!

ECLIPSUM

CONCEPT



Quick access to full technical data sheet

A parasol doesn't get any rounder than the Eclisum UX by Umbrosa. The new Eclisum UX may look the same as its predecessor, but you'd be surprised. The parasol has been reinforced on several levels: wind resistance, stronger glass fibres and better rotation axis.

DESIGNER

NG Design

USP

The only truly round parasol: an iconic shade object.

SELLING POINTS

- Very easy to use
- Pole and ring rotate 360°
- Unique eye catcher on your terrace
- Canopy is easy to install and to store

VERSIONS

ECLIPSUM UX



FULL BLACK

From \$ 10 702

Ø 9'10"



ARCHITECTURE

From \$ 10 702

Ø 9'10"



KARIM RASHID

From \$ 12 200

Ø 9'10"

ECLIPSUM PX

NEW



ECLIPSUM PX

From \$ 10 702

Eclipsum PX freely combinable: 1 size, 2 frame colors, 8 fabric colors

FRAME COLORS

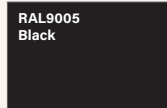
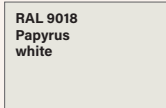

CANOPY COLORS

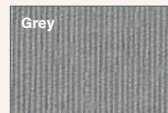
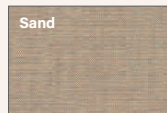
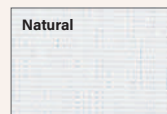
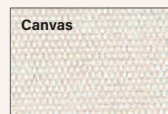
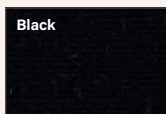





ECLIPSUM UX

Production lead time: 4 weeks

PRICE frame + canopy + support + protection cover					
	Dimension	(1)	Concrete anchorage incl. (2) INGROUNDANCHORTYPE1	Mobile UX base incl. (3)	
ECLIPSUMNARCHI_UX	Ø 9'10"	\$ 10 702	\$ 11 058	\$ 13 667	TILEBASEUX-ARCHI
ECLIPSUMNBLACK_UX	Ø 9'10"				TILEBASEUX-L-BLACK
ECLIPSUM2N-KRASHID	Ø 9'10"	\$ 12 200	\$ 12 557	\$ 15 165	TILEBASEUX-L-KRASHID

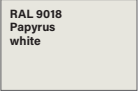
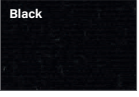
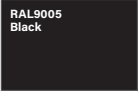
UX combinations Eclisum

Material		Material		Material	
Canopy	Frame + Base	Canopy	Frame + Base	Canopy	Frame + Base
					
ARCHITECTURE		FULL BLACK		KARIM RASHID	

REPLACEMENT CANOPIES

	Description	Price excl. sales taxes
ECLIPSUMCOVERN-BLACK	9'10" Black	\$ 1 588
ECLIPSUMCOVERN-MARBL	9'10" Marble	
ECLIPSUMCOVN-KRASHID	9'10" unique design Karim Rashid	\$ 1 898

PROTECTION COVER

	Description	Price excl. sales taxes
ECPROTECTION_UX	Cover bag Flanelle with fiberglass stick.	\$ 491

(1) Fixation on hard ground (2) Fixation in soft ground (3) Use on mobile parasol base
For easy mounting, order spacer in addition!

ECLIPSUM UX

MOUNTING OPTIONS AND BASES

		Description	Finish	Price excl. sales taxes
Hard ground		When you want to install the umbrella on a solid surface, it is recommended to order a spacer so that you don't have to make a cutout in the surface.	HDPE	\$ 129
SPACER1				
Soft ground		Concrete anchorage to install the pole in a "soft" ground pouring concrete. To use in combination with a round support.	Galvanized steel	\$ 357
INGROUNDANCHORTYPE1				
Mobile bases		Mobile large UX base set: base - cover - wheels - 70.55 lbs (add at least 396 lbs of weight with tiles) - 35" x 35" x 8.7". Tiles not included.	Black - RAL 9005	\$ 2 965
TILEBASEUX-L-BLACK			Papyrus White - RAL 9018	
TILEBASEUX-L-ARCHI			Telemagenta - RAL 4010	\$ 2 965
TILEBASEUX-L-KRASHID				



ECLIPSUM PX

Production lead time : 4 week

CHOOSE YOUR COMBINATION

1. FRAME COLOR



ECFRAMEPAPY_UX



ECFRAMEBLACK_UX

2. CANOPY COLOR

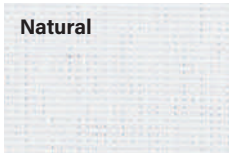

ECLIPSUMCOVERN-NATUR

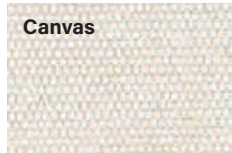

ECLIPSUMCOVERN-CANV

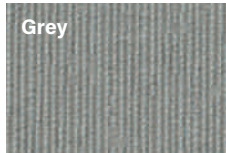

ECLIPSUMCOVERN-GREY



ECLIPSUMCOVERN-TAUPE

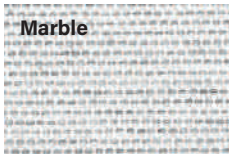

ECLIPSUMCOVERN-MARBL

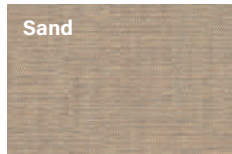

ECLIPSUMCOVERN-SAND



ECLIPSUMCOVERN-FLANE

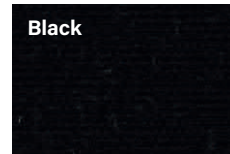

ECLIPSUMCOVERN-BLACK

3. BASE

A. Top plate



RAL9018
Papyrus white
PAPYBASETOPPLATEUX



RAL9005
Black
BLACBASETOPPLATEUX



Thermo
Poplar*
WOODBASETOPPLATEUX

B. Frame base



RAL 9018
Papyrus white
PAPYBASEFRAMEUX



RAL9005
Black
BLACBASEFRAMEUX

* Our UX wooden covers are made of thermotreated poplar wood that has not been treated for color stability. The wood will weather with outdoor exposure and turn grey.

ECLIPSUM PX

PRICE PX frame + canopy + support + protection cover			
	(1)	Concrete anchorage incl. (2) INGROUNDANCHORTYPE1	Mobile base incl. (3)
Eclisum PX	\$ 10 702	\$ 11 058	\$ 13 667

Prices for replacement canopies, see UX collection.
Price for the protection cover, see UX collection.

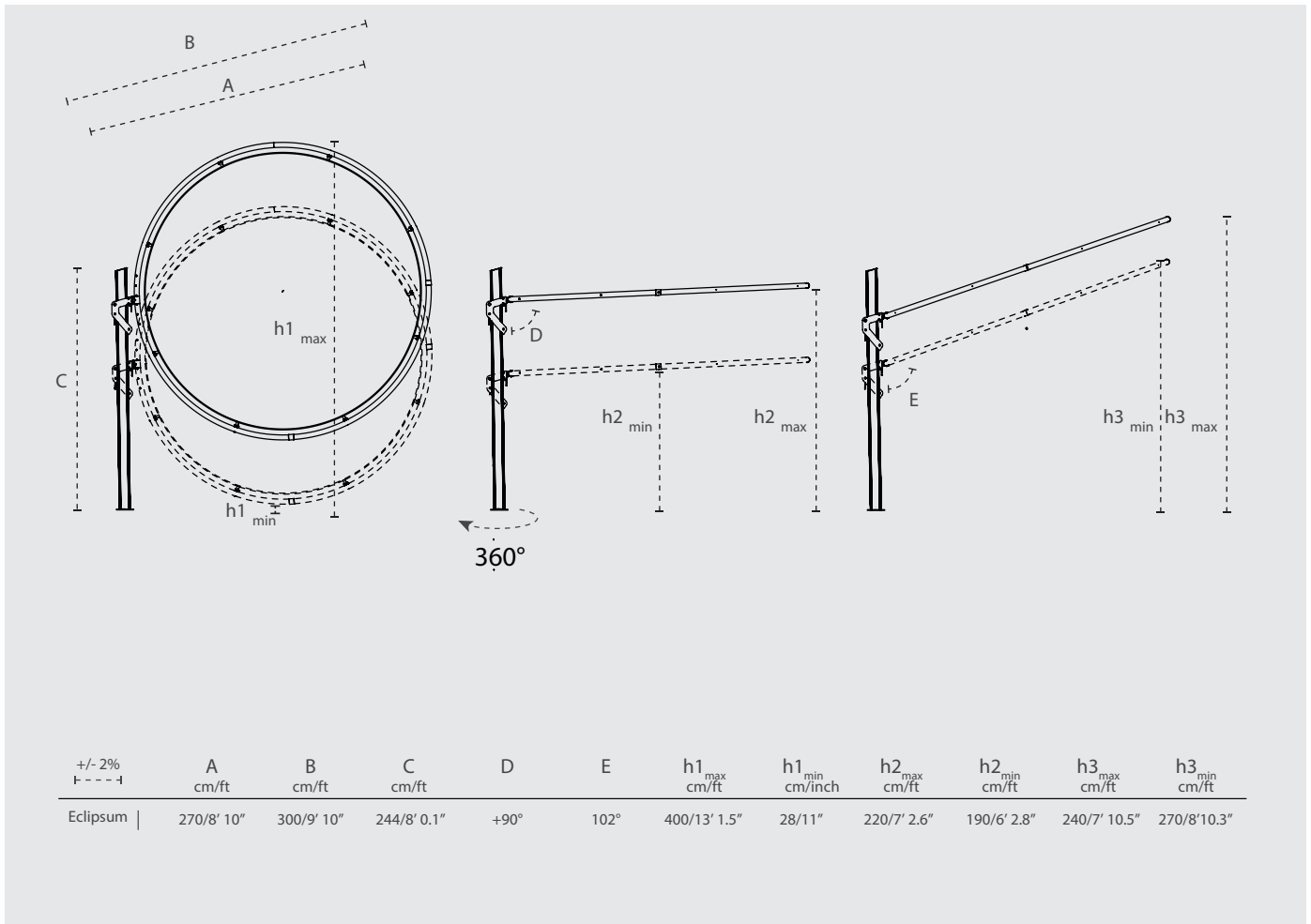

Attention: To reduce its ecological footprint, Umbrosa no longer includes the tiles with the bases. We recommend our customers to source those locally.
TILEBASE = frame + cover + wheels - tiles not included

(1) Fixation on hard ground (2) Fixation in soft ground (3) Use on mobile parasol base
For easy mounting, order spacer in addition!

WARRANTY

UMBROSA LIMITED WARRANTY CONDITIONS

THIS LIMITED WARRANTY (THE "WARRANTY") GIVES YOU SPECIFIC LEGAL RIGHTS AND YOU MAY ALSO HAVE OTHER RIGHTS, WHICH VARY FROM STATE TO STATE.

SOME STATES DO NOT ALLOW LIMITATIONS ON HOW LONG AN IMPLIED WARRANTY LASTS, SO LIMITATIONS AS TO DURATION OF THIS WARRANTY MAY NOT APPLY TO YOU.

OUR RESPONSIBILITY FOR DEFECTIVE OR DAMAGED PRODUCTS IS LIMITED TO REPAIR OR REPLACEMENT, AS DESCRIBED IN THIS WARRANTY.

Capitalized terms used but not defined herein shall be given the meaning assigned to them in the Umbrosa Terms and Conditions of Sale ("Terms") to which this Warranty is attached and incorporated by reference.

Umbrosa always adheres to the warranty obligations of Belgian, European, and American manufacturers in accordance with the applicable law.

This limited warranty covers defects in materials and workmanship of Products, including those sold in Custom Orders and standard orders, sold by Umbrosa, Inc. ("Umbrosa"). All warranty requests must first be submitted to the retailer or website where the Product was purchased. This Warranty starts on the date of purchase of the Product and extends for the applicable time as listed in the "Special Limited Warranty Provisions" sections below. All warranty claims must be submitted with an original proof of purchase dated from the dealer of origin, and a description of the damaged Product, including how the damage occurred and photos of the damaged Product. This Warranty may not be assigned and is available only to the original purchaser of the Products; provided, however, for Resellers who otherwise distribute the Products with Umbrosa's consent, such Resellers may claim the benefit of this Warranty on behalf of their customers.

Umbrosa strives to develop and produce high-end, high-quality, and sustainable products that are optimized to withstand weather conditions and the environment in which they are used. All Umbrosa products are extensively tested to ensure good quality (including tests conducted at the University of Delft (NL) wind tunnel, and component testing with independent research laboratories), but Umbrosa cannot guarantee that its Products will never have defects.

Use of the warranty always requires the presentation of the original purchase invoice.

www.umbrosa.com details the information necessary to process the warranty request efficiently and quickly. This information must be provided to the retailer or website where the Product was purchased in order for the retailer or website to process the warranty request on the customer's behalf. Warranty requests must always be submitted in writing within 30 days after the initial observation of the issue. Umbrosa guarantees that, if covered by this Warranty, the problem will be solved at Umbrosa's sole option, through repair or replacement of the defective Products.

The warranty does not restart in case of replacement with a new product, unless otherwise required by law.

In case of a defect in an Umbrosa Product and upon the receipt of a warranty request in accordance with this Warranty, Umbrosa will, at its option, repair or replace the Product in accordance with the Special Limited Warranty Provisions in this Warranty. Unless specified otherwise in this warranty, in connection with a valid claim under this Warranty and in Umbrosa's sole discretion, Umbrosa will provide replacement parts and ship them to the customer free of charge. Umbrosa is not responsible for any other costs, including costs associated with replacing or installing Product parts or components.

DIRECT OR INDIRECT DAMAGE CAUSED BY (I) IMPROPER USE; (II) FAILURE TO FOLLOW INSTALLATION, USE, OR MAINTENANCE INSTRUCTIONS AS POSTED ON UMBROSA'S WEBSITE; (III) MODIFICATIONS TO THE PRODUCT NOT AUTHORIZED BY UMBROSA; (IV) UNAUTHORIZED REPAIR; (V) NORMAL WEAR AND TEAR, OR (VI) EXTERNAL CAUSES SUCH AS ACCIDENTS, ABUSE, OR OTHER ACTIONS OR EVENTS BEYOND UMBROSA'S REASONABLE CONTROL (INCLUDING, BUT NOT LIMITED TO, WIND, SNOW, HAIL, HURRICANES, STORMS, AND OTHER EXTREME WEATHER CONDITIONS, PRODUCTS FALLING AND STRIKING THE GROUND OR ANOTHER OBJECT OR BEING STRUCK BY FALLING MATERIAL) ARE NOT COVERED BY THIS WARRANTY.

The biggest threat to the lifespan of Umbrosa Products are weather conditions and external environmental factors. Therefore, always provide the appropriate care for any Umbrosa Product and never leave it open unattended. Damage caused by incorrect use or extreme weather conditions including, but not limited to, wind, snow, hail, hurricanes, and storms, is not covered by this Warranty. Gusts of wind can be more powerful than average wind speed. **Damage caused by any wind, including average wind speed or gusts, that exceeds 30 km/hour (4 Beaufort) is not covered by this Warranty. Damage caused when Products are left unattended or by poor fixation or use of weak supports is not covered by this Warranty.** In addition, in any weather condition, the strap and protection cover need to be correctly used in accordance with usage instructions found on the Umbrosa website and the product manual when closing and opening any Product. Failure to do so can cause damage even when the Product is closed, and **this kind of damage is not covered by this Warranty.**

The use of a mobile or movable base has an impact on the wind resistance of the Product. Therefore, always select a base that is heavy enough to ensure stability. Always contact the distributor or Umbrosa should you desire advice on the anchoring method to be used with your Product. www.umbrosa.com contains a large amount of information on this topic. **Direct and indirect damage caused by a falling Product, whether it is in open or closed position, is not covered by the warranty.**

With intensive usage of the Products in a hostile environment, such as near the sea, sand, chlorine, or heavy pollution, the frame and canopy of the Product should be rinsed regularly using fresh water in order to prevent the build-up of salt residue. Maintenance instructions for Products can be found on Umbrosa's website. **Damage to Products due to failure to maintain the Product in accordance with the maintenance instructions on Umbrosa's website is not covered by this Warranty.**

Umbrosa uses natural products or materials such as wood, concrete, and granite that are susceptible to weather conditions and thus naturally age. **This natural aging process in outdoor conditions is not covered by this Warranty. Likewise, Umbrosa cannot guarantee that its products will be free from stains due to animal excrement, pollution phenomena and/or differences in the natural materials used in production.**

The Products are subject to normal wear and tear. This warranty covers damaged caused by construction or manufacturing defects only. **Scratches, superficial corrosion, wear due to use, and any other cause are not covered by this Warranty.**

The warranty shall be void and unenforceable if any components or accessories not approved by Umbrosa are used with the Product.

ALL SPECIAL LIMITED WARRANTY PROVISIONS BELOW ARE SUBJECT TO THE FOREGOING WARRANTY RESTRICTIONS AND EXCLUSIONS.

SPECIAL LIMITED WARRANTY PROVISIONS FOR HARDWARE

These Special Warranty Provisions are only applicable when the Products are used according to the guidelines and restrictions in this Warranty, including compliance with the maintenance instructions as found on www.umbrosa.com and the requirements specified above.

10-year warranty

Umbrosa offers a 10-year warranty on all aluminium extrusion profiles as used in the Icarus, Eclipsium and Spectra.

5-year warranty

Umbrosa offers a 5-year warranty on all glass fiber ribs as used in Spectra and Icarus Products and all welded tubes as used in Paraflex and Infina Products. Colour differences are not covered by this warranty.

Umbrosa offers a 5-year warranty on all stainless steel parts. Scratches, superficial corrosion, and wear due to use are not covered by this Warranty unless the product is structurally weakened as a result.

3-year warranty

Umbrosa offers a 3-year warranty on all synthetic parts and all galvanized steel parts. Scratches and wear due to use are not covered by this Warranty unless the product is structurally weakened as a result.

2-year warranty

Umbrosa offers a 2-year warranty on its granite bases, tile bases, and mobile concrete bases.

In case of breakage, the new replacement concrete part may be a different colour than the original, this is unavoidable.

Umbrosa offers a 2-year warranty on all painted parts of its Products. Whenever the paint flakes off or forms bubbles, Umbrosa, at its option, will replace the damaged item or present a custom solution.

SPECIAL LIMITED WARRANTY PROVISIONS FOR FABRICS & TEXTILE PREFABRICATION

Apart from the existing Colorum range, Umbrosa has, in cooperation with Agora and Sunbrella, developed its own fabric with strong warranty conditions. This fabric is called 'Solidum'.

5 year warranty (except for protection covers)

Our fabric is engineered for strength, resilience, and longevity. **Burn holes, melted holes, or fabric deformation can only be caused by misuse of a Product and are therefore not covered by this Warranty.** Daily protection of the umbrella using the protective cover extends the lifespan of the umbrella.

WARRANTY

With use of Colorum and Solidum fabric in all Products, a 5-year warranty is offered for discolouration and structural integrity. In the exceptional case of discolouration, Umbrosa, at its option, will offer a new canopy. If a new canopy is offered, the customer is responsible for cutting & prefabrication costs, and Umbrosa is responsible for shipping costs. Under no circumstances will discolouration result in a new canopy free of charge.

For no other Product is usage intensity as well as exposure to UV so different from user to user. Due to the intensive usage of Ingenua sails, very specific warranty conditions apply to this collection.

The warranty on these sails in Sunbrella and Solidum covers discolouration and structural integrity. For continental Europe, this warranty is 3 years. Outside of continental Europe, the warranty is 2 years.

In the exceptional case of discolouration, Umbrosa, at its option, will offer a new canopy. If a new canopy is offered, the customer is responsible for cutting & prefabrication costs, and Umbrosa is responsible for shipping costs. Under no circumstances will discolouration result in a new canopy free of charge.

1 year warranty for zippers

Zippers must be used in accordance with usage instructions found on the Umbrosa website and the product manual. If the zipper is stiff, this issue can quickly be resolved using a silicone spray or another non-oil-based lubricant. In case of zipper breakage within the one-year warranty period, Umbrosa will send a replacement zipper free of charge.

PAYMENT DETAILS

Invoice payments by ACH or Wire transfer. Checks are not accepted.

Bank details:

KBC Bank N.V., New York Branch

FED ABA: 026008248

ACH: 026008248

CHIPS ABA: 824

SWIFT: KREDUS33

ACCOUNT NAME: Umbrosa Inc.

ACCOUNT NUMBER 10977201

Payment by credit card upon request.

SAFETY STATEMENTS & WARNINGS

- Product is suitable for light wind and/or light rain only.
- Position product in direction of wind as recommended in user manual.
- Do not use product in inclement weather, such as strong wind, thunderstorms, heavy rain or snow, and make sure that the umbrella is closed and stored in advance.
- Never allow the umbrella to flap in the wind. This could cause personal injury, damage to personal property, damage to umbrella and/or umbrella canopy.
- Close product and secure strap when not in use.
- Do not use product without its base or unless attached to building structure, and keep umbrella secured to umbrella base or mount at all times.
- Do not use product over or near harsh chemicals or open flames.
- Place product on stable and level surface.
- Do not allow children to assemble or operate product.
- Do not leave product unattended.
- Store product indoors during winter and extreme weather conditions.
- When adjusting or assembling the umbrella or umbrella base, make sure fingers, toes or any other parts of the body are clear from moving parts. Failing to do so may result in serious injury.
- Only use Umbrosa replacement parts.
- Read owner's manual.
- Any modifications to the product or failure to follow recommended care will void the warranty.
- Wind damage is not covered under our limited warranty.

BEAUFORT SCALE

BEAUFORT N°	DESCRIPTION	KM/U	MPH	EFFECTS OBSERVED ON LAND
1	Light air	1-5	1-3	Direction of wind shown by smoke drift.
2	Light breeze	6-11	4-6	Wind felt on face, leaves rustle.
3	Gentle breeze	12-19	7-10	Leaves and small twigs in constant motion, wind extends light flag.
4	Moderate breeze	20-28	11-16	Raises dust and loose paper, small branches are moved.
5	Fresh breeze	29-38	17-21	Small trees in leaf begin to sway, crested wavelets form on inland waters.
6	Strong breeze	39-49	22-27	Large branches in motion, umbrellas used with difficulty.
7	Near gale	50-61	28-33	Whole trees in motion, inconvenience felt in walking against the wind.
8	Gale	62-74	34-40	Breaks twigs of trees.
9	Strong gale	75-88	41-47	Slight structural damage occurs (chimney pots and slate removed).
10	Storm	89-102	48-55	Trees uprooted, considerable structural damage occurs.

PRODUCT STRENGTH ACCORDING TO THE BEAUFORT SCALE*

PRODUCT	BFT SCORE	PRODUCT	BFT SCORE
PARAFLEX / PARAFLEX UX/PX	3 - 6	INGENUA	4 - 8
SPECTRA / VERSA UX/PX	4 - 7	ECLIPSUM UX/PX	5 - 6
NATA / NATA UX	5 - 6	ICARUS / ICARUS UX/PX	5 - 9

* The wind scores are valid for a parasol placed on the ground floor. For installation of a parasol on another, higher floor, contact Umbrosa for the best possible solution.

TIPS FOR THE IDEAL WIND POSITION

NATA / NATA UX

For Nata, we advise to avoid wind from below (1), to fully open the canopy and put the umbrella on a flat surface. When closing the umbrella the strap needs to be correctly used. Failure in doing so can cause damage even in a closed position.

PARAFLEX / PARAFLEX UX / PARAFLEX PX

For Paraflex (UX/PX) we advise to position the arm following the direction of the wind (1), completely stretch out the arm (2), place the grip in between the ribs (3), put the umbrella horizontally (4) and on a flat surface.

SPECTRA / VERSA UX / VERSA PX

For Spectra, Versa (UX/PX), we advise to position the umbrella in the direction of the wind (1), put the arm in a 10° angle (2) and put the umbrella on a flat surface.

ICARUS / ICARUS UX / ICARUS PX

For Icarus (UX/PX), we advise to position the umbrella in the direction of the wind (1), put the umbrella in a slight upward position (2) and put it on a flat surface.

ECLIPSUM UX / ECLIPSUM PX

For Eclisum (UX/PX), we advise to position the umbrella in the direction of the wind (1), put the circle under a slight angle (2) and put it on a flat surface.

INGENUA

For Ingenua, we advise you to put the sail in a angled position to prevent wind from getting under the sail (1); to put full tension on the sail only by using the Umbrosa ropes and dogbones (2) and to install the poles in a backward position (3).

GENERAL

When closing the umbrella, the strap and protection cover need to be correctly used. Failure in doing so can cause damage, even in a closed position.

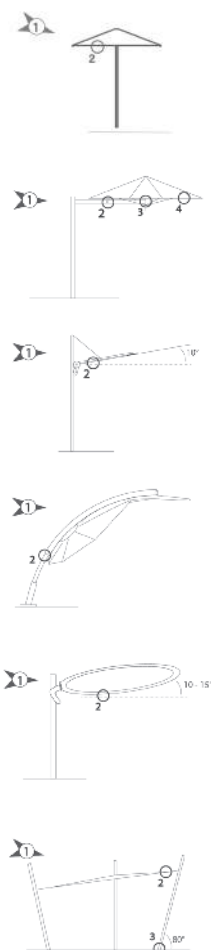

UMBROSA

UNIQUE SHADE DESIGN

UMBROSA INC - 530 7th Avenue, Suite 902 - New York, NY 10018 - tel: (855) 285-6595 - info@umbrosa.com - www.umbrosa.com